

AQUATIC

Designed for luxury. Engineered for life.



Millennium Series

Owner's Manual & Installation Guide

Note: Read all instructions before proceeding with installation.
All specifications are $\pm 1/4''$ and are subject to change without notice.

AQUATIC

TABLE OF CONTENTS

PRODUCT REGISTRATION/WARRANTY CARD	3
CONGRATULATIONS!	5
SAFETY INSTRUCTIONS	6
INSTALLATION INSTRUCTIONS	
Pre-Installation Procedures	7
Structural Preparation	8
Plumbing	9
Rough-In Measurements	9
Fast-Fill Waterfall Spout	9
Electrical Installation	10
Millennium Series Electrical Wiring Schematic-- Whirlpool and Heater	11
Inline Heater Wiring and Operating Instructions	12
OPERATION	
Electronic Controls	13-15
Universal Remote Control	16-23
Jet Operations	24-26
User Information	27
FCC Information	27
Serial Number - How to Locate	27
MAINTENANCE AND CARE	
Initial Cleaning	28
Whirlpool System Cleaning	28
Surface Cleaning	28
Jet Cleaning	28
Surface Scratch Removal	29
Repair	29
Water Quality Issues	29-30
TROUBLESHOOTING GUIDE	
Symptoms/Possible Problems/Solutions	31
Universal Remote Set-Up Codes	32-36
PARTS ORDER FORM/PARTS MAPS/PARTS LIST	
Parts Order Form	37
Parts Order Maps	38-40
Parts List	41-42
AQUATIC LIMITED WARRANTY	43

AQUATIC INDUSTRIES, INC.

Warranty Confirmation & Product Registration Information

IMPORTANT:

To ensure that your warranty is registered and confirmed with the manufacturer, please take a few moments to complete, sign and return the Product Registration Card (below) within **30 days** of date of purchase.

WARRANTY CONFIRMATION:

By returning this Product Registration Card, we can confirm the date of purchase for your new product. This confirmation will allow Aquatic Industries, Inc. to process any warranty claims.

PURCHASE REGISTRATION:

The information provided on the Product Registration Card will be kept on file with Aquatic Industries, Inc. as your official Purchase Registration.

While completing the card, please take time to also fill in the owners information to the right, as this will help expedite any warranty claims, should the need arise.

OWNER INFORMATION:

Model Name

Serial Number

(See Table of Contents for Location)

Purchase Date

Distributor

AQUATIC

P.O. Box 889 • Leander, TX 78646-0889
Phone (800) 928-3707 • Fax (888) 296-7450

AQUATIC INDUSTRIES, INC.

Product Registration Card

To ensure that your warranty is registered with Aquatic Industries, Inc., complete, sign and return this registration card within 30 days of date of purchase or installation. NOTE: Your warranty will not be recognized by Aquatic Industries, Inc. unless this card is fully completed and returned to Aquatic Industries, Inc., P.O. Box 889, Leander, TX 78646-0889.

NAME _____ DISTRIBUTOR _____

ADDRESS _____ CITY _____

CITY _____ STATE _____ ZIP _____ TUBMODEL _____ COLOR _____

PHONE _____ DATE PURCHASED _____ SERIAL # _____

I have read the Aquatic Industries, Inc. Owner's Manual carefully and understand and agree that any installation, operation or maintenance of the whirlpool must be done strictly in accordance with instructions and guidelines contained in the Aquatic Industries, Inc. Owner's Manual and Installation Guide provided by Aquatic Industries, Inc. to my Aquatic Industries, Inc. Distributor.

SIGNATURE _____

5/06

AQUATIC

CONGRATULATIONS!

You have chosen one of the finest bath products in the world! Aquatic Industries supports your purchase with strong commitments to quality and customer satisfaction. Please read and follow all of the instructions contained in this Owner's Manual before installing, operating or maintaining your whirlpool. In addition, you should continually refer to these instructions during the life of your whirlpool. Failure to comply with these instructions may invalidate your warranty. If you have any questions concerning installation, operation, maintenance or any other aspect of your whirlpool, please contact:

AQUATIC INDUSTRIES CUSTOMER SERVICE CENTER: 800.928.3707

(The Troubleshooting Guide on page 31 may be helpful in answering some of your questions.)

NOTE:

The installation and service of your whirlpool should be performed **ONLY** by a qualified electrician and plumber.

IMPORTANT!

This product **MUST BE WATER-TESTED** and inspected prior to installation or warranty will be voided. See page 7 for instructions.

PLEASE CHECK ENTIRE UNIT FOR ANY DAMAGE.

If it appears damaged, contact your Aquatic Distributor **immediately**.

Aquatic Industries, Inc. warranty does not cover damage that occurs in transit.

IMPORTANT SAFETY INSTRUCTIONS

WARNING: WHEN USING THIS UNIT, THESE BASIC PRECAUTIONS SHOULD BE FOLLOWED.

This manual contains information and instructions for proper operation and maintenance of your whirlpool. Failure to follow these instructions could result in personal injury, electrical shock or fire.

READ AND FOLLOW ALL INSTRUCTIONS

DANGER! TO REDUCE THE RISK OF INJURY:

1. Do not permit children to use this unit unless they are closely supervised by an adult at all times. Supervision is also required when whirlpool bath is used by an elderly or handicapped individual.
2. Use this unit only for its intended use as described in this manual. Do not use attachments not recommended by the manufacturer.
3. Do not operate this unit without guard over the suction fitting.
4. The water in a whirlpool should never exceed 40°C (104°F). Water temperatures between 38°C (100°F) and 40°C (104°F) are considered safe for a healthy adult. Use time should be limited to approximately 30 minutes, followed by a shower to cool down. Longer exposures may result in hyperthermia. The symptoms of this condition are nausea, dizziness and fainting, which can be fatal. Lower water temperatures are recommended for extended use (exceeding 10-15 minutes) and for young children.
5. Since excessive water temperatures have a high potential for causing fetal damage during the early months of pregnancy, pregnant or possibly pregnant women should limit whirlpool water temperatures to 38°C (100°F).
6. The use of drugs or alcoholic beverages before or during whirlpool use may lead to unconsciousness with the possibility of drowning. Never use the whirlpool while under the influence of alcohol, anticoagulants, stimulants, antihistamines, vasoconstrictors, vasodilators, hypnotics, narcotics or tranquilizers.
7. Persons with a medical history of heart disease, low or high blood pressure, circulatory system problems, or diabetes should consult a physician before using a whirlpool.
8. Persons using medication should consult a physician before using a whirlpool since medication may induce drowsiness while other medication may affect heart rate, blood pressure and circulation.

DANGER: To reduce the risk of injury, enter and exit the bath slowly.

WARNING: Never operate electrically connected devices in or near the bath. Never drop or insert any object into any opening within the whirlpool.

This unit must be connected to a supply circuit that is protected by a Ground Fault Circuit Interrupter (GFCI). Such a device should be installed by a licensed electrician and should be tested on a regular basis (at least monthly). To test the GFCI push the **TEST** button. The GFCI should interrupt the power. Push the **RESET** button and the power should be restored. If the GFCI fails to operate in this manner there is the possibility of an electric shock. **DO NOT USE.** Disconnect the unit and have the problem corrected by a qualified service technician. To avoid the possibility of personal injury and discoloration of the acrylic surface, the inlet water temperature should not exceed 60°C (140°F). The bath should be drained after each use. Each bather should start their bath with fresh water.

CAUTION: DO NOT USE HARSH ABRASIVES OR SOLVENTS FOR CLEANING THIS UNIT.

INSTALLER/OWNER BEARS ALL RESPONSIBILITY TO COMPLY WITH ALL STATE AND LOCAL CODES WHEN INSTALLING THIS PRODUCT.

SAVE THESE INSTRUCTIONS

INSTALLATION

INSTRUCTIONS / GUIDELINES

READ ALL INSTRUCTIONS CAREFULLY BEFORE INSTALLATION

PRE-INSTALLATION PROCEDURES:

PLEASE NOTE: THE MANUFACTURER ACCEPTS A 1/4" VARIANCE. THERE ARE VARIATIONS ON EACH TUB AND SPECIFICATIONS ARE SUBJECT TO CHANGE AS WE IMPROVE UPON OUR PRODUCT AS REQUIRED.

THE DIMENSIONS NEEDED FOR SITE PREPARATION AND STRUCTURE BUILDINGS SHOULD BE MEASURED FROM THE TUB; AQUATIC INDUSTRIES, INC. ASSUMES NO RESPONSIBILITY FOR PREPARATORY WORK.

Note: A good knowledge of construction techniques, plumbing and electrical installation according to codes are required for proper installation. We recommend that a qualified licensed contractor perform the installation of all Aquatic products. Our warranty does not cover improper installation related problems.

WARNING: All units are shipped with loose unions. Before attempting to test, install, or use your whirlpool, all pump and heater unions a "O" rings must be repositioned and/or tightened.

1. Immediately upon receiving your Aquatic Industries, Inc. whirlpool bath inspect it thoroughly for freight damage. If necessary, contact your dealer/distributor immediately (your dealer/distributor must contact Aquatic Industries, Inc. within 24 hours of receiving unit to file a claim.) Should inspection indicate any damage, do not install the bath.
2. All baths are filled with water and operated in our manufacturing facility prior to shipment. Inspectors ensure watertight operation, however, rough handling may cause leaks which may be detected prior to installation.

DAMAGE OR DEFECT TO THE FINISH CLAIMED AFTER THE BATH IS INSTALLED IS NOT COVERED UNDER THE WARRANTY.

TO INSPECT:

3. Place the tub in an area where it may be drained after testing.
4. Fill the tub with hot water (approximately 100° F) to the overflow and allow to stand for a few minutes. Carefully inspect all fittings and connections for leaks.
5. Connect the 220 vac four wires to the control box. Run both pumps for 10 minutes.
6. With the pump running, turn on the blower. Check all functions.
7. Inspect the tub completely. Any defect must be reported to Aquatic Industries, Inc. prior to installation in order to have it covered by warranty. Should inspection indicate any damage, do not install the bath.
8. Check to ensure that your installation will conform to all applicable codes and secure necessary permits. All electrical and plumbing connections should be made by qualified electricians and plumbers.

DAMAGE OR LEAKS CLAIMED AFTER THE BATH IS INSTALLED ARE NOT COVERED UNDER THE WARRANTY.

WARNING: FAILURE TO FOLLOW THESE INSTRUCTIONS DURING INSTALLATION WILL RESULT IN TERMINATION OF THE WARRANTY: Do not lift the tub by any portion of the plumbing or pump. Do not stand in the tub during construction.

DO NOT MAKE ANY ALTERATIONS, ADDITIONS, OR DELETIONS TO THE WHIRLPOOL SYSTEM PUMP OR BATH.

WARNING: Whirlpool pump and piping are factory assembled. Relocation of pump or other modifications could adversely affect the performance and safe operation of this whirlpool. Aquatic Industries, Inc. shall not be liable under its warranty or otherwise for personal injury or damage caused by any such unauthorized modification.

QUIETNESS OF OPERATION: Aquatic has engineered their whirlpool baths from base to lip to ensure quality, value, functional design, and maximum bathing comfort. However, installation is accountable for as much as 50% of a tub's operating quietness. Please ensure the following:

- The floor structure is adequate to support the installation.
- For quieter operation and heat retention conservation, the walls surrounding the whirlpool may be insulated.
- Leave 1/8" to 3/16" gap between tub lip and surround.

INSTALLATION INSTRUCTIONS

STRUCTURAL PREPARATION:

Note: The bath should remain in its shipping carton until time of installation.

- Literature dimensions are for reference only. **INSTALLATION DIMENSIONS SHOULD BE TAKEN DIRECTLY FROM THE TUB. WIDTH OF ACCESS IS INDICATED BY DARK LINE. HEIGHT OF ACCESS IS A MINIMUM OF TWO FEET MEASURED FROM THE BOTTOM OF LIP.**

An access panel of at least:

- Millennium VII (See Diagram A)
 - Millennium VIII (See Diagram B)
 - Millennium IX (See Diagram C)
 - Millennium X* (See Diagram D)
- *Needs two access panels

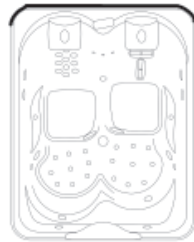

Millennium VII
Diagram A

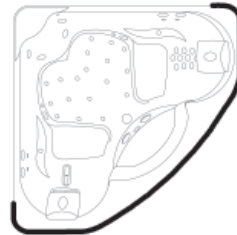

Millennium VIII
Diagram B



Millennium IX
Diagram C



Millennium X
Diagram D

IT IS THE INSTALLER'S RESPONSIBILITY TO PROVIDE SUFFICIENT SERVICE ACCESS AND TO ENSURE THAT ACCESS PANELS AND/OR SERVICE OPENINGS ARE PROPERLY PLACED AND ACCESSIBLE.

- Install the drain fitting to the bath. **THE DRAIN FITTING MAY PROTRUDE BELOW THE BASE OF THE TUB.** Clearance must be provided for the drain by cutting away the subfloor (where possible) or by blocking below the tub as may be required. **WARNING:** All blocking must be solid and provide uniform support to the tub base.
- Tub must rest entirely on all leveling feet. **DO NOT SUPPORT THE WEIGHT OF THE TUB BY THE RIM.** Lift unit and place into framework. If necessary, adjust feet until unit is completely touching on the leveled sub floor. Secure the unit by fastening the bottom feet to the sub floor with any construction adhesive caulk or screw the feet to the floor. For quieter operation and heat conservation, the walls surrounding the whirlpool may be insulated.
- Frame out under the tub rim as shown in one of the illustrations below. **NOTE:** Due to the variety of installations possible, framing procedures other than those described may be required. Plumb in selected location using a level. Level front to back and across both sides. A ledge under the rim, or an apron without a ledge, may be constructed as required (see Diagrams 1A, 1B and 1C). Where installation will be against a wall, stud wall framing should allow for wall sheathing material to run full length to the floor (see Diagram 1D). Install tub firmly against sheathing as indicated, with blocking below rim to prevent deflection or movement of tub. To prevent a rocking movement of tub after installation, it is important to have rim in contact, but not supported by blocking material.
- When placing the tub on a platform or cut out (see Diagrams 1A, 1B and 1E), the opening should be 1" smaller than the specified rim dimensions. Extreme care must be taken in this type of installation to ensure the tub will come to rest entirely on the leveling feet.

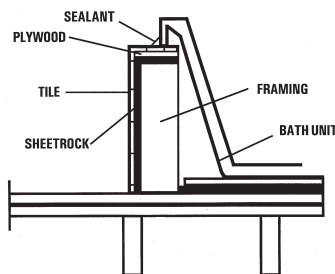

1A Ledge Installation-1

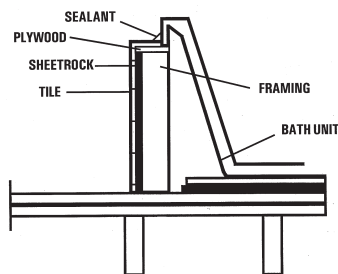

1B Ledge Installation-2

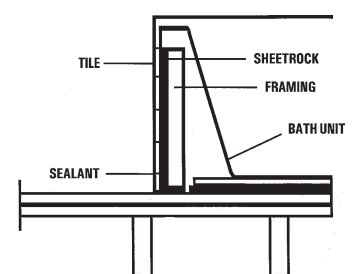

1C Apron Installation

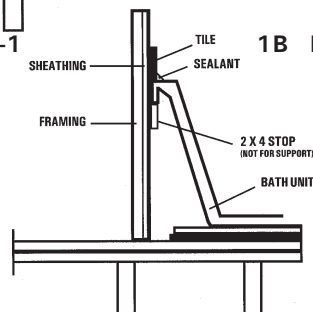

1D Wall Installation

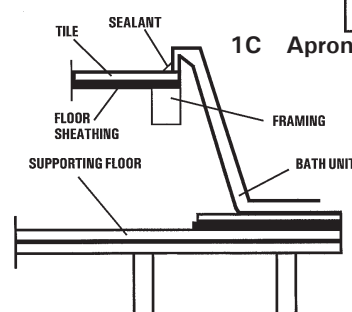

1E Sunken Installation

WARNING: ALL ELECTRICAL CONNECTIONS SHOULD BE MADE BY A LOCALLY LICENSED ELECTRICIAN/TECHNICIAN.

INSTALLATION INSTRUCTIONS

PLUMBING:

1. After securing bath in place, normal waste and overflow and valves are installed per normal plumbing procedures, in accordance with all state and local standards.
2. Install standard 1-1/2" trap to drain and overflow. Before proceeding make final operational check by filling tub with water to overflow and operate pumps for 5 minutes. Check for leaks carefully both while pump is running and has been turned off. Allow water to stand in tub for at least 30 minutes before draining. **AQUATIC INDUSTRIES, INC. WILL NOT BE RESPONSIBLE FOR WATER DAMAGE OF ANY KIND IN CONNECTION WITH ONE OF OUR WHIRLPOOL BATHS.** Aquatic recommends the use of 3/4" valves.
3. All Millennium Series models are equipped with an integral Fast-Fill Waterfall Spout (unless ordered without this feature). Purchasing a spout is unnecessary, however, hot and cold water valves are needed. Valves can be mounted where you choose, however, if installation is to be on tub deck, check the back side of the tub for adequate space for connection to water lines before drilling or cutting tub.

ROUGH-IN MEASUREMENTS:

See Diagram 3A, below

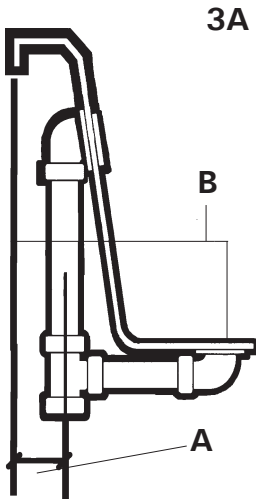

MODEL

Millennium VII
 Millennium VIII
 Millennium IX
 Millennium X

A

2 1/4"
 6 1/2"
 3 1/4"
 5 3/4"

B

31 1/2"
 41"
 35"
 26"

PLEASE NOTE: THE MANUFACTURER ACCEPTS A 1/4" VARIANCE. THERE ARE VARIATIONS ON EACH TUB AND SPECIFICATIONS ARE SUBJECT TO CHANGE AS WE IMPROVE UPON OUR PRODUCT AS REQUIRED.

THE DIMENSIONS NEEDED FOR SITE PREPARATION AND STRUCTURE BUILDING SHOULD BE MEASURED FROM THE TUB; AQUATIC INDUSTRIES, INC. ASSUMES NO RESPONSIBILITY FOR PREPARATORY WORK.

FAST-FILL WATERFALL SPOUT:

The Fast-Fill Waterfall Spout will be stubbed as in Diagram 3C.

WARNING: DO NOT OVER TIGHTEN! DO NOT USE TEFLON TAPE. Damage to fitting is not covered under warranty.

3B



FROM VALVES

Fast-Fill Waterfall Spout is stubbed out with a 3/4" female threaded PVC fitting.

3C

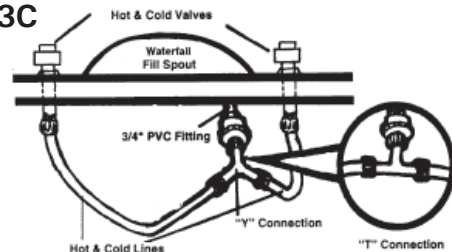

INSTALLATION INSTRUCTIONS

NOTE: Before bath is used, the whirlpool system should be cleaned in accordance with the procedures on page 28 of this manual.

ELECTRICAL INSTALLATION:

WARNING: ALL ELECTRICAL CONNECTIONS SHOULD BE MADE BY A LICENSED, LOCALLY CERTIFIED ELECTRICIAN, IN ACCORDANCE WITH THE REQUIREMENTS OF THE NATIONAL ELECTRICAL CODES AND PROCEDURES.

WARNING: WHEN USING ELECTRICAL PRODUCTS, BASIC PRECAUTIONS SHOULD ALWAYS BE FOLLOWED, INCLUDING THE FOLLOWING.

DANGER: RISK OF ELECTRIC SHOCK! Connect only to circuits protected by a Ground Fault Circuit Interrupter (GFCI). A GFCI is not supplied, however, we do specify its use. All known code authorities require a GFCI.

Rough-in wiring to control package: One 220V, 4 wire, 50 AMP GFCI protected circuit.

CAUTION! RISK OF ELECTRIC SHOCK!

A green colored terminal (or wire connector marked "G", "GR", "Ground" or "Grounding") is provided within the terminal compartment. To reduce the risk of electric shock, connect this terminal or connector to the grounding terminal of your electric service or supply panel with a continuous green insulated copper wire equivalent in size to the circuit conductors supplying this equipment.

A pressure wire connector is provided on the exterior of the terminal box within this unit to permit connection of a NO. 8 AWG (8.4 mm²) solid copper bonding conductor between this unit and all other electrical equipment and exposed metal in the vicinity, as needed to comply with state and local requirements.

Bonding wire: Connect a #8 bare copper bonding wire from the pump motor or motors, heater and light's ground lug to the cold water plumbing or other suitable ground. Grounding is required. The unit should be installed by a qualified electrician and grounded as specified above.

For built-in and custom units, install to permit access for servicing.

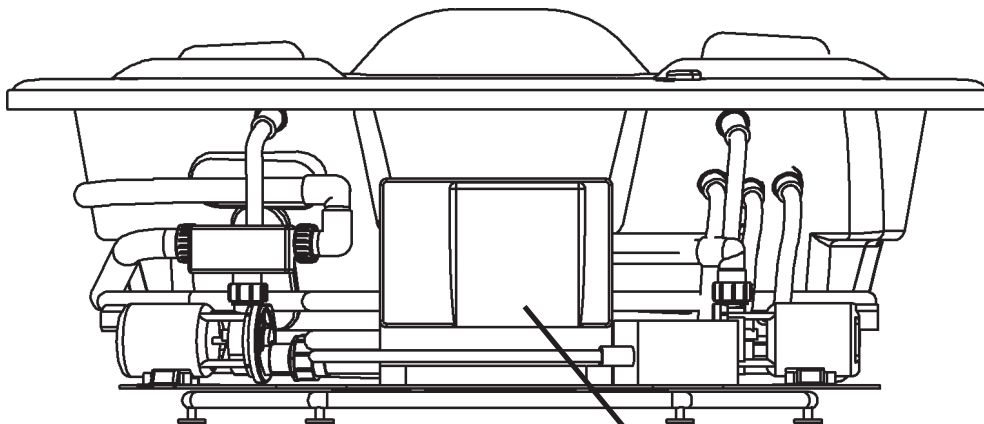

Typical Millennium electronic placement shown. Exact locations vary per model.

INSTALLATION INSTRUCTIONS

INLINE MAINTENANCE HEATER WIRING AND OPERATING INSTRUCTIONS:

The whirlpool Inline Maintenance Heater is totally self-contained to ensure trouble free operation. Operation can be controlled from the electronic panel (see page 13 for further information). The heater will maintain the temperature of the water in the bathtub. As with all electrical devices, certain safety precautions should be taken during wiring and use. Please read and follow all these instructions carefully.

FEATURES OF THE INLINE MAINTENANCE HEATER

HI-LIMIT: The heater includes an exclusive "Smart Hi-Limit." This Hi-Limit will not "false trip" from hot tap water. It will only turn heater off if the thermostat fails. If the water temperature reaches the "High Limit", the display will show "OH" to indicate the problem. The next touch of the control pad will try to reset the high-limit circuit.

INDICATOR LIGHT: This light turns on when heater is operating.

SAFETY FEATURES: In addition to the thermostat and Hi-Limit, the heater is equipped with a built-in pressure switch. This switch will not allow the heater to turn on if the pump is not running.

WARNING: RISK OF ELECTROCUTION! All electrical connections should be performed by a licensed electrician in compliance with local and national electrical codes. In addition, a GFCI **MUST** protect all branch circuits to the whirlpool.

1. One 220V, 4 wire, 50 AMP GFCI protected circuit.
2. Use copper conductors only.
3. Insure the heater and pumps are properly **GROUND**ED and pump is **BONDED** as required.

CAUTION: Before use of the pumps and heater, test the GFCI for proper operation. The pumps and heater should turn off when the GFCI "Test" button is pushed.

WARNING: Prolonged Immersions in Hotter Water May Induce Hyperthermia.

Hyperthermia occurs when the internal temperature of the body reaches a level several degrees above the normal body temperature of 98.6°F. The symptoms of hyperthermia include an increase in the internal temperature of the body, dizziness, lethargy, drowsiness, and fainting. The effects of hyperthermia include (1) failure to perceive heat, (2) failure to recognize the need to exit the whirlpool, (3) unawareness of impending hazard, (4) fetal damage in pregnant women, (5) physical inability to exit the whirlpool, (6) unconsciousness resulting in the danger of drowning.

WARNING: The use of alcohol, drugs, or medication can greatly increase the risk of fatal hyperthermia.

OPERATION of MILLENNIUM SERIES

NOTE: DO NOT START PUMP UNTIL THE WATER LEVEL SENSOR IS SUBMERGED (SEE DIAGRAM 5B).

BATH-SIDE CONTROL SYSTEMS:

ELECTRONIC CONTROLS:

Your **Millennium Series model** comes standard with two, 2 HP, three-speed pumps. These pumps are controlled by separate electronic keypads (see right and following page). The main keypad controls all pump functions for lounge #1, in addition to activating the chromatherapy lighting and heater (see diagram 5A). The secondary control pad (see page 14, diagram 5C) controls pump functions for lounge #2, in addition to the chromatherapy lighting and blower. The third keypad controls the Shiatsu-Pro Jet Sequencer for lounge #2 (see page 14, diagram 5D).

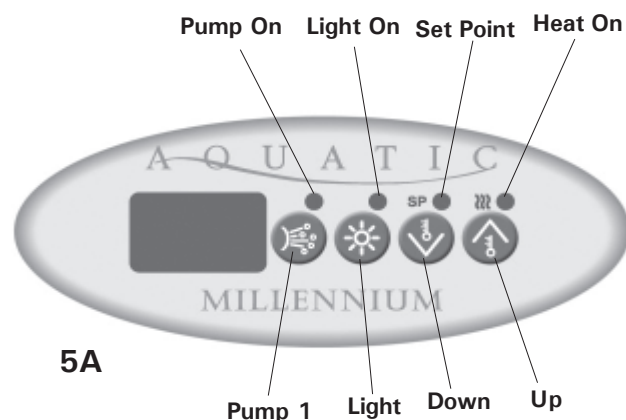

MAIN KEY PAD (Diagram 5a):

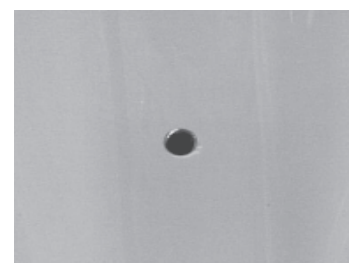

The main key pad is equipped with a 3-digit display, four status lights and four function keys.

- To Turn Pump On:**  One depression of the On/Off button will turn the pump on at its highest speed. A second depression will change the speed to medium, a third will change the speed to low and a fourth will turn the pump off. **Note:** When power is applied, the unit displays program version and revision for 10 seconds and then blinks. The pump will shut off automatically after 20 minutes of operation. **WARNING:** All Millennium Series whirlpools are equipped with a water level sensor (See Diagram 5B). When the water level sensor detects the water level, the pump and heater will automatically turn on to begin regulating the temperature to the set point you have chosen (see section entitled "To Change Temperature"). **NOTE:** The pump and heater will only automatically turn on when the temperature of the water in the tub is below the set point temperature you have chosen. To prevent automatic activation, adjust the set point well below the temperature of the water until you have entered the whirlpool and have manually turned the pump on.



5B

WARNING: To avoid self activation of pump after using the whirlpool, do not begin cleaning or wiping down the whirlpool until the water has completely drained.

- To Change Temperature:**   These two keys are used to set the set point. When they are pressed, the display will show the current set point. The user can change this set point by pressing the up or down key. These keys have a "typematic" function, meaning that by holding down the keys, the set point will change continuously. The set point can vary from 41° to 104° F. The display will continue to show the set point 5 seconds after the up or down key has been released.

Note: The set point LED is on when the display shows the set point and is off when it shows the actual bath temperature. The default set point at power up will be 95°F. The unit will turn the heater on when the temperature reaches the set point - 1°F and will keep it on until it reaches the set point + 1°F. If pump one is off when the heater must be turned on, the control will start pump one automatically.

- To Turn On Chromatherapy Lighting:**  One depression of the light button will turn fiber optic motor and light on. The colors will rotate every 5 seconds. A second depression will stop the fiber optic motor and maintain the current color. A third depression will turn the light off.

OPERATION of MILLENNIUM SERIES





BATH-SIDE CONTROL SYSTEMS:

KEYPAD #2 (Diagram 5C):

The second keypad has 5 function keys, as shown:

5C



1. **To Turn Pump #2 On:**  One depression will turn pump #2 on at its highest speed. A second will change the speed to medium, a third will change the speed to low and a fourth will turn pump #2 off.
2. **To Turn On Chromatherapy Lighting:**  One depression of the light button will turn fiber optic motor and light on. The colors will rotate every 5 seconds. A second depression will stop the fiber optic motor and maintain the current color. A third depression will turn the light off.
3. **To Turn Air Bath System On:** Pressing the On/Off  button will turn the blower on in "constant mode". Once the blower is on, pressing a second time will turn the blower off. The blower and the blower heater will shut off after a 20-minute period.
4. **To Change Modes:** Pressing the Mode  button alternates the blower modes of operation from constant mode to wave mode and then to pulse mode.
 - Constant Mode: Consists of a constant blower speed with no change.
 - Wave Mode: Consists of a gradual change of blower speed to generate a gentle massage effect.
 - Pulse Mode: Consists of the blower turning off and on to generate a massage effect.
5. **To Change Speeds:** In constant mode, pressing the  blower speed key once will display the current lower speed. Successive presses toggles between increasing and decreasing blower speed. 1 = lowest speed, 10 = highest speed

Note: The blower heater is on only when the blower is at full speed in constant mode.

KEYPAD #3 (Diagram 5D)

The third keypad controls the Shiatsu-Pro jet sequencer.

5D



1. **To Turn Jet Sequencer On:** Pressing the "On/Off" button will turn the jet sequencer on. The system will then perform an indicator light test and open all valves. Pressing the "On/Off" button a second time will turn the jet sequencer off. A built-in timer automatically turns the jet sequencer off after 2 hours, unless manually deactivated first. **NOTE:** Pump 2 must be turned on for the jet sequencer to be effective (see Key Pad #2 instructions above 5C).
2. **To Choose Sequences:** Press the "Sequences" button to select one of the 6 preprogrammed massage sequences. Note: A preview of the massage is displayed for 5 seconds after selecting a sequence.
3. **To Change Speeds:** Press the "Speeds" button to change the time interval between each step of the selected massage sequence.

Speed 1: 15 Seconds between each step.
 Speed 2: 10 Seconds between each step.
 Speed 3: 5 Seconds between each step.

OPERATION of MILLENNIUM SERIES

BATH-SIDE CONTROL SYSTEMS:

4. **To Pause:** Press the "Pause" button to stop a massage sequence. Pressing a second time will resume the massage sequence. The "Pause" indicator light will be on in "Pause" mode.

OTHER FEATURES:

- **High Limit:** If the water temperature reaches the highest level allowed (119° F), the display will show "OH" to indicate the problem. A press of any key on the pad will reset the high limit circuit.
- **Heat On:** The "Heat On" LED will indicate when the heater is on or off.
- **Safety Features:** In addition to the thermostat and High Limit, the heater is equipped with a built-in pressure switch. This switch will not allow the heater to turn on unless the tub is filled with water and pump #1 is running.
- **H2O:** If either pump is turned on before the water has reached the water level sensor, "H2O" will be displayed. Add more water until the water level sensor is submerged.

Automatic Purge: Thirty minutes after the jet sequencer has shut off, it will start again for a 5-minute purge cycle allowing piping to dry.

Note: Pump #1, Pump #2 and the blower are on the same timer. If anyone of these are started, the timer will be re-set to 20 minutes.

MILLENNIUM AIR PURGE CYCLE (See Diagram 5C on page 14):

Following the 20 minute run time on the blower, there will be a 15 minute idle period. The blower will then turn on for 5 minutes for the purge cycle. If the user turns the blower off manually before the timer reaches 20 minutes, the idle period will start after the blower has been turned off. During the idle period, pressing the on/off button will turn on the blower in constant mode. During the 5 minute purge, pressing the blower key will stop the purge.

PURGE 24 HOURS:

It is possible for the user to program a purge cycle that will start every day for a duration of 5 minutes. Aquatic strongly recommends activating this feature. The purge cycle will help ensure that the air channels stay dry even when you have taken a soaking bath.

To activate this purge feature, the user must hold down the "+/-" key for 5 seconds when the blower/heater is off or waiting for the normal purge. If the unit was in stand-by for a normal purge when the 24 hour purge was activated, the normal purge will be cancelled. The purge will be done every day at the same time the user activated it (pressed +/- key).

TROUBLESHOOTING:

- **Water Level Sensor:** If water level sensor detects water level in bathtub that is too low, the system will prevent pump from starting and "H2O" message will be displayed for 5 seconds. The pump will be allowed to turn back on if water level returns above sensor.
- **OH Message:** The heater is turned off when temperature at the hi-limit sensor reaches 119° F. The "OH" message will be displayed. Press any key to reset system.
- **Prr Message:** A problem has been detected with the temperature probe. Please contact your distributor.
- **FLO Message:** The system detects no water pressure while pumps are running. Check water level. Please contact your distributor if problem persists.
- **FLC Message:** A problem has been detected with the pressure switch. Please contact your distributor.

OPERATION of MILLENNIUM SERIES

UNIVERSAL REMOTE CONTROL:

For best results, please remove the Universal Remote from the water when the whirlpool is not in use. Prolonged exposure to the hot water in your bath may create humidity build-up inside your remote control. This will not affect the operation of the remote, but may alter its appearance.

Please read these instructions carefully to ensure optimal use of your Universal Remote Control.

The Millennium Universal Remote Control can control four of the following devices:

1. Whirlpool
2. Audio Equipment (CD, Tuner, Amplifier and Audio Cassette)
3. Video Equipment (TV, DVD and VCR)
4. Home Automation

The remote control has 17 keys and also features the following:

- Pre-programmed Universal Codes
- Quick Search Mode
- IR Learning Mode
- Reassignable Device Keys
- Ergonomic Design
- Floatable
- Totally Sealed
- 3 "AAA" Batteries in Watertight Compartment. The Universal Remote retains values of memorized codes even after having replaced the batteries.

REPLACING THE BATTERIES:

Your Universal Remote is powered by three AAA batteries.

1. Unscrew and remove bottom cap to Universal Remote.
2. Insert new batteries, making sure to match plus (+) ends with plus markings on the battery case. Refer to the label under your remote.
3. Replace cap ensuring that waterproof gaskets are correctly positioned and cap is well screwed on.

Notes:

- You can use a coin to unscrew cap.
- When replacing batteries, it is recommended to add a lubricant (e.g. Vaseline) on cap gaskets to ensure perfect water tightness.

OPERATION of MILLENNIUM SERIES

UNIVERSAL REMOTE CONTROL:

KEY CHARTS:

Use the Key Charts below to learn how the Universal Remote works. Note: When pressing a key, backlighting is turned on for 5 seconds. If backlighting is flashing in learning mode, this is normal.

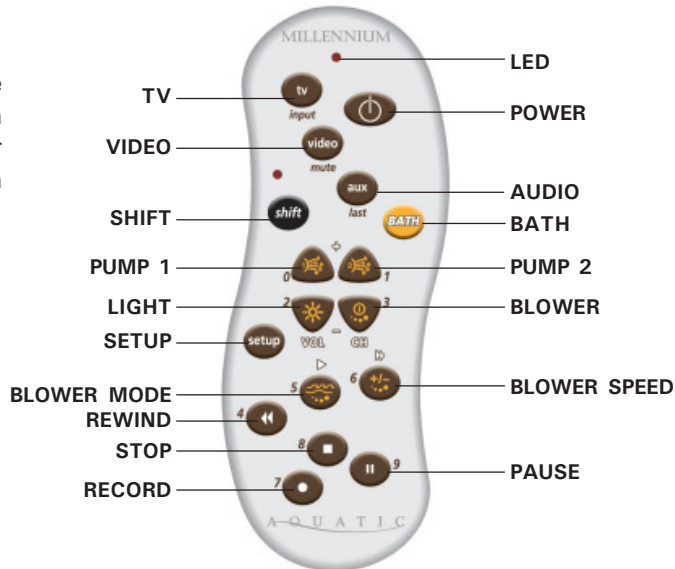

When pressing a key, the **LED** blinks to show that the remote control is working and sending signals.



Use **Setup** for all programming sequences.



Press **Power** once to turn on or off the selected home entertainment device.



Press **tv**, **video**, **aux** or **bath** once to select a home entertainment device to control.



Use **VOL +** or **VOL -** to increase or reduce sound volume (or to control **Pump 1** and **Light** in Bath Mode).



Use **CH +** or **CH -** to change channels (or to control Pump 2 and Blower in Bath mode).



Use **Rewind**, **Play** or **Forward** in video mode.



Use **Stop**, **Pause** or **Record** in video mode.



While holding **shift**, press one of the following keys to select secondary functions (**LED** lights up above key):

Use the numbers (**0-9**) to select channels or for all programming codes.



Press **mute** once to turn sound off or on.



Press **last** once to recall last channel and to page back one screen in the main menu.



Press **input** once to switch the input of chosen device.

Time-Out: 10 seconds after pressing a key, the remote will exit the current programming mode.

Record Safety: To record a program, press Record key twice. This is to prevent accidental recordings (this applies to Video and Audio modes only).

OPERATION of MILLENNIUM SERIES

UNIVERSAL REMOTE CONTROL:

PROGRAMMING DEVICE CONTROL:

The Universal Remote can control up to four different devices. Carry out the following instructions for each device you want to control.

Default setup code numbers:

TV	0047	RCA
VCR	0060	RCA
AUX	1023	Pioneer

MODE	CODE
TV	Code for TV
VIDEO	Code for DVD, VCR, Audio Cassette, LDP, DAT
AUX	Code for Amplifier, Tuner, Misc. Audio, CD, Home Automation
BATH	Code for the Bath (0420)

Write down your setup code numbers in the chart below, for future reference.

TV	<input type="text"/>	<input type="text"/>	<input type="text"/>	<input type="text"/>
VCR	<input type="text"/>	<input type="text"/>	<input type="text"/>	<input type="text"/>
AUX	<input type="text"/>	<input type="text"/>	<input type="text"/>	<input type="text"/>
BATH	<input type="text" value="0"/>	<input type="text" value="4"/>	<input type="text" value="2"/>	<input type="text" value="0"/>

Note:

The code for your Sony CDX-C6750 or CDX-C5000 Radio / CD is **0179**.

1. Turn on a device (e.g., VCR) and, if applicable, insert media (e.g. video cassette).

Note:

Please read steps 2-4 completely before proceeding. We recommend highlighting the codes and device you wish to program before moving on to step 2.

2. On the remote control, press mode key once (i.e., tv, video, aux or bath). Press and hold **setup** until LED blinks twice, then release key.
3. Use the Code Table (pages 32-36) to locate brand name and type of device. Then, enter the four-digit code for your device. If performed correctly, the LED will blink twice. Remember to press and hold **shift** key first to access numbers (0-9).

Note:

If LED did not blink twice, then repeat steps 2-3 and try entering the same code again.

4. Aim remote control at device and press **Power** once. It should turn off. If it does not respond, repeat steps 2-3, trying each code for your brand until you find one that works. If it still does not work, try searching for the code (see Searching For Your Code, page 19).
5. Repeat steps 1-4 for each device you want the Universal Remote to control.

OPERATION of MILLENNIUM SERIES

UNIVERSAL REMOTE CONTROL:

SEARCHING FOR YOUR CODE:

If your device does not respond to the Universal Remote after trying all codes listed for your brand, or if your brand is not listed at all, try searching for your code.

Simply substitute the appropriate mode key (i.e., **tv**, **video**, **aux** or **bath**) for the device you are searching for and repeat steps 1-5.

1. On the Universal Remote press mode key once (**tv**, **video**, **aux** or **bath**).
2. Press and hold **setup** until LED blinks twice, then release key.
3. Enter **9-9-1**. LED will blink twice. Remember to press and hold **shift** key first to access numbers (**0-9**).
4. Aim remote control at TV and slowly alternate between pressing **Power** and **tv**. Stop when the TV turns on.
5. Press **setup** once to lock in the code.

Note:

- LED blinks three times when the sequence has been completed.
- Instead of pressing **Power**, you can use **0**, **1**, **2**, **3**, **CH +**, **VOL +**, **Play** and **Stop**.
- In Search mode, the Universal Remote will send IR codes from its library to the selected device, starting with the most popular code first or with the current programmed code.

CHECKING CODES:

If you have set up the Universal Remote using the "Searching For Your Code" procedure, you may need to find out which four-digit code is operating your equipment.

Simply substitute the appropriate mode key (i.e., **tv**, **video**, **aux** or **bath**) for the device you are checking and repeat steps 1-5.

1. On the Universal Remote, press mode key once (**tv**, **video**, **aux** or **bath**).
2. Press and hold **setup** until LED blinks twice, then release key.
3. Enter **9-9-0**. LED will blink twice. Remember to press and hold **shift** key first to access numbers (**0-9**).
4. To view the code for the first digit, press **1** once. Then count the LED blinks (e.g., 3 blinks = 3) and write down the number.
5. Repeat steps 4 three more times for the remaining digits. Use **2** for the second digit, **3** for the third digit, and **4** for the fourth digit.

Note:

- If a code digit is "0", LED will not blink.
- Remember to press and hold **shift** key first to access numbers (**0-9**).

OPERATION of MILLENNIUM SERIES

UNIVERSAL REMOTE CONTROL:

LEARNING MODE:

The Universal Remote has the ability to learn new functions from your original remote controls.

Note: To optimize success, the learning process should be conducted in an area where there is a low level of IR emission. High levels of natural light or energy efficient florescent lights could interfere with a learning event. The source and target remote should be no more than 1 to 2 inches apart during a learning event and the IR LED's of the two units should be aligned with each other. It is important to use new batteries on the source remote. (Refer to page 21 to read limitations about the learning mode.)

The learning operation is initiated as follows:

1. Press and hold **setup** until LED blinks twice to initiate learning mode, then release key.
2. Enter **9-7-5**. LED will blink twice. Remember to press and hold **shift** key first to access numbers (**0-9**).
3. Press mode key (**tv, video, aux** or **bath**).
4. Hold teaching remote close to LED.
5. On the Universal Remote, press key to be learned. LED flashes rapidly.
6. Press and hold key to be taught until LED on universal remote blinks twice.
7. LED turns off.
8. Repeat steps 3-7 as often as desired (up to limit of memory).
9. Exit learning mode by pressing and holding **setup** until LED blinks twice, or by time-out (if remote remains untouched for more than 10 seconds).

Note:

- At step 6, one long blink indicates learning failure, which could be:
 - Bad capture (try again)
 - Memory full (delete some other function, see page 21)
 - Unlearnable code
- At step 2, one long blink indicates low battery or memory full (i.e. the unit will not go into Learning mode if either of these conditions exist).
- If your memory is full, delete one function (setup, 9, 7, 6; see page 20) or delete all (setup, 9, 8, 1 or 9, 8, 0; see page 21).

DELETING A LEARNED FUNCTION:

If your memory is full, you will need to delete one or more functions on your Universal Remote. Here is how to delete one function:

1. Press and hold **setup** until LED blinks twice, then release key.
2. Enter **9-7-6**. LED will blink twice. Remember to press and hold **shift** key first to access numbers (**0-9**).
3. Press mode key once (**tv, video, aux** or **bath**).
4. Now press twice on the key you want to delete. Learned function reverts to original function.

Note:

The LED blinks two times after successful completion of deleting sequence. There will be 2 blinks and one long blink if there is a problem with the remote. Remote goes back to normal operation after 10 seconds.

OPERATION of MILLENNIUM SERIES

UNIVERSAL REMOTE CONTROL:

DELETING A LEARNED FUNCTION (continued):

Limitations:

1. There are certain device codes which are not learnable (or others that once they are learned can create a bad functionality).
2. The unit can learn only one code per key.
3. All keys with the exception of **shift**, **setup** and the mode keys (**tv**, **video**, **aux**, **bath**) can be learned on.
4. During a learning event, the source remote and target should be no more than 1 to 2 inches apart.
5. The learning process should be conducted in an area where there is a low level of IR emission. High levels of natural light or energy efficient fluorescent lights could interfere with a learning event.
6. In general, it is not recommended to learn a function to **Record** key because it requires a double key press to send the record function in normal operation.
7. Typically, there are up to 24 keys that can be learned.

DELETING FUNCTIONS AND CODES:

If your memory is full, you will need to delete one or more functions on your Universal Remote. Here is how to delete all functions and codes:

Deleting all learned functions:

1. Press and hold **setup** until LED blinks twice, then release key.
2. Enter **9-8-0**. LED will blink twice. Remember to press and hold **shift** key first to access numbers (**0-9**).

Note:

- All learned functions are deleted and remote reverts to original functions.
- The LED blinks two times, pause then blinks 2 more times after successful completion of the programming sequence.

Deleting all learned functions and codes:

1. Press and hold **setup** until LED blinks twice, then release key.
2. Enter **9-8-1**. LED will blink twice. Remember to press and hold **shift** key first to access numbers (**0-9**).

Note:

- The remote resets all learned functions and codes.
- The LED blinks two times, pause then blinks 2 more times after successful completion of the programming sequence.

OPERATION of MILLENNIUM SERIES

UNIVERSAL REMOTE CONTROL:

REASSIGNING DEVICE KEYS:

The Universal Remote can be set up to control a second TV or DVD / VCR, or any combination of the three home entertainment devices.

For example, to have the Universal Remote control a TV and two VCR's, you will need to reassign the unused aux key to operate the second VCR as follows:

1. On the Universal Remote, press and hold **setup** until LED blinks twice, then release key.
2. Enter **9-9-2**. LED blinks twice. Remember to press and hold **shift** key first to access numbers (**0-9**).
3. Press **video** once, then press **aux** once.
4. The **aux** key is now ready to be programmed for your second VCR. See Programming Device Control on page 18.

To reassign other device keys, repeat steps 1-4 by substituting the key sequence from the chart opposite for the most popular devices.

To reassign key:

SEQUENCE	PERFORM
TV as 2nd Video Key	setup-9-9-2-video-tv
TV as 2nd AUX key	setup-9-9-2-aux-tv
TV back to TV	setup-9-9-2-tv-tv
VIDEO as 2nd TV key	setup-9-9-2-tv-video
VIDEO as 2nd TV key as 2nd AUX key	setup-9-9-2-aux-video
VIDEO back to Video	setup-9-9-2-video-video
AUX as 2nd TV key	setup-9-9-2-tv-aux
AUX as 2nd Video Key	setup-9-9-2-video-aux
AUX back to AUX	setup-9-9-2-aux-aux

CHANGING VOLUME LOCK:

The Universal Remote is set to control volume of device through your TV while in TV or Video mode.

Note: In an Audio mode, you have separate control of your audio device's volume. If your TV is not remote controllable, or if you want volume to be controlled by a different device, you can change the Volume Lock setting to control a volume through a non-associated mode (e.g., through the aux. in TV mode).

To change Volume Lock to another mode:

1. On the Universal Remote, press and hold **setup** until LED blinks twice, then release key.
2. Enter **9-9-3** and then any mode key once (except **tv**). LED will blink twice.
3. Now, whenever you press **VOL +**, **VOL-** or **mute**, volume will be controlled by the mode you chose.

To change Volume Lock back to TV mode:

1. On the Universal Remote, press and hold **setup** until LED blinks twice, then release key.
2. Enter **9-9-3** and then press **tv**. LED will blink twice.
3. Now, whenever you press **VOL +**, **VOL-** or **mute** on the Universal Remote, volume will be controlled by your TV.

OPERATION of MILLENNIUM SERIES

UNIVERSAL REMOTE CONTROL:

TROUBLESHOOTING:

If you have a problem with your Universal Remote Control, refer to the list below:

Problem: LED does not blink when you press a key.

Solution: Replace the batteries with three new AAA alkaline batteries (refer to page 16).

Problem: LED blinks when you press a key, but home entertainment device or bath does not respond.

Solution: Make sure the Universal Remote is aimed at your home entertainment device and is not further than 15 feet away.

Problem: The Universal Remote does not control home entertainment devices or commands are not working properly.

Solution: Try all listed codes for the device brands being set up. Make sure they can be operated with an infrared remote control.

Problem: No volume on a second TV.

Solution: Follow instructions in Changing Volume Lock on page 22.

OPERATION of MILLENNIUM SERIES

JET OPERATIONS:

To ensure the user gets the most therapeutic benefit from an Aquatic Whirlpool, our engineers have designed jet placement that provides an invigorating, rejuvenating massage. Aquatic prides itself on using the highest quality hydrotherapy jets available. Most Millennium Series jets are removable, and can be put into the dishwasher for easy cleaning. The Fan Jet can be cleaned by simply using a bottle brush and warm, soapy water.

SHIATSU-PRO NECK AND BACK JETTING SYSTEM:

Note: Rotary Massage Elite Jets and Pressure Plus Jets are located in the Shiatsu-Pro Neck and Back Jetting System. **See instructions below:**

- **To Adjust Pressure (see Diagram 6B):**
 1. Grasp the outer ring of the jet.
 2. Turn the outer ring clockwise to increase flow, counter-clockwise to shut off.
- **To Adjust Circular Pattern (see Diagrams 6B and 6C):**
 1. Using your fingertip, move jet eye to desired location.
- **To Remove Jet (see Diagram 6D):**
 1. Grasp the outer ring of the jet.
 2. Turn the jet counter-clockwise, until the jet clicks, then pull.
- **To Replace Jet or Change Jet (see Diagram 6D):**
 1. Insert the jet into jet housing. **NOTE: DO NOT FORCE!**
 2. Turn the jet clockwise, past point of resistance, until the jet clicks.

6A



6B



6C



6D



PULSATING NECK JET PILLOWS:

The Pulsating Neck Jet Pillows offer a comfortable place to rest your head while enjoying the luxury of a soothing neck massage. The Pulsating Neck Jet is pressure adjustable by simply turning the jet. The Neck Jet can be removed and placed in the dishwasher for easy cleaning. (See Maintenance and Care, page 28)

- **To Remove/Replace Pillow (see Diagram 7A):**
 1. To Remove: Grasp the pillow from the top and pull out and down.
 2. To Replace: Line up loop tape on pillow with loop tape on the tub and press firmly.
- **To Adjust Pressure (see Diagram 7B):**
 1. Grasp the outer ring of the jet.
 2. Turn the jet clockwise to increase flow, counter-clockwise to shut off.
- **To Remove Jet (see Diagram 7C):**
 1. Grasp the outer ring of the jet.
 2. Turn the jet counter-clockwise, until the jet clicks, then pull.
- **To Replace Jet or Change Jet (see Diagram 7C):**
 1. Insert the jet into jet housing. **NOTE: DO NOT FORCE!**
 2. Turn the jet clockwise, past point of resistance, until the jet clicks.

7A



7B



7C



OPERATION of MILLENNIUM SERIES

JET OPERATIONS:

AQUATIC ROTARY MASSAGE ELITE JET:

The Rotary Massage Elite Jet generates a powerful rotating massage action that is directional and pressure adjustable for custom flexibility. The Rotary Massage Elite Jets massages the back in the Shiatsu-Pro Neck and Back Jetting System. It also focuses massage action on the foot and knee areas.

- **To adjust pressure (see Diagram 8A):**

1. Grasp the outer ring of the jet.
2. Turn the outer ring clockwise to increase flow, counter-clockwise to shut off.

- **To adjust circular pattern (see Diagrams 8A, 8B, and 8C):**

1. Small circular pattern: slide the nozzle until it is positioned in the center of the jet.
2. Medium circular pattern: slide the nozzle to the desired location for a medium pattern.
3. Large circular pattern: slide the nozzle to the desired location for a large pattern.

- **To remove jet (see Diagram 8D):**

1. Grasp the outer ring of the jet.
2. Turn the jet counter-clockwise, until the jet clicks, then pull.

- **To replace jet (see Diagram 8D):**

1. Insert the jet into jet housing. **NOTE: DO NOT FORCE!**
2. Turn the jet clockwise, past point of resistance, until the jet clicks.

8A

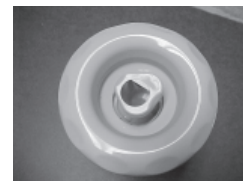

8B



8C



8D



FAN JET:

The Aquatic Fan Jet (see Diagram 9A) is deeply recessed for greater comfort during bathing. It covers an 8" to 12" area of the body with oscillating streams of air and water, like tiny hands, to massage tired and aching muscles. Operation of this jet is automatic. The Fan Jet is a permanent jet fixture and should not be removed from the tub, but cleaned with a bottle brush and warm, soapy water.

9A



OPERATION of MILLENNIUM SERIES

PRESSURE PLUS JET:

The Pressure Plus Jet massages the back in the Shiatsu-Pro Neck and Back Jetting System. It also provides an effective massage to the elbow and wrist areas.

- ***To adjust pressure (see Diagram 10A):***

1. Grasp the outer ring of the jet.
2. Turn the jet clockwise to increase flow, counter-clockwise to shut off.

- ***To remove jet (see Diagram 10B):***

1. Grasp the outer ring of the jet.
2. Turn the jet counter-clockwise, until the jet clicks, then pull.

- ***To replace or change jet (see Diagram 10B):***

1. Insert the jet into jet housing. **NOTE: DO NOT FORCE!**
2. Turn the jet clockwise, past point of resistance, until the jet clicks.

10A



10B



USER INFORMATION

PLEASE NOTE:

The whirlpool action may cause even small amounts of bubble bath or shampoo to foam excessively. Exercise moderation in experimenting with different soap products.

No servicing of this product should be done by the user. There are no user serviceable parts. All controls are located in the control recesses on the lip of the tub. These are the only controls that should be used by the consumer. Do not change or alter any of these controls under any circumstances.

Motors are self-lubricating -- No lubrication required.

FCC CONSUMER INFORMATION

Electrical Installation Information Listed on Page 10.

This equipment generates and uses radio frequency energy and if not installed and used properly, that is, in strict accordance with the manufacturers instruction, may cause interference to radio and television reception. It has been type tested and found to comply with the limits for a class B computing device in accordance with the specifications in subpart J of part 15 of the FCC rules, which are designed to provide reasonable protection against such interference in a residential installation. However, there is no guarantee that interference will not occur in a particular installation. If this equipment does cause interference, which can be determined by turning the equipment on and off, the user is encouraged to try to correct the interference by one or more of the following measures:

- Reorient the receiving antenna
- Relocate the receiver with respect to the bath tub.
- Move the receiver away from the bath.
- Plug the receiver into a different outlet so that the receiver and bath are on different branch circuits.
- If necessary, the user should consult the dealer or an experienced radio/television technician for additional suggestions.
- The user may find the following booklet prepared by the Federal Communications Commission helpful: "How To Identify and Resolve Radio-TV Interference Problems."

This booklet is available from the U.S. Government Printing Office, Washington, DC 20402, Stock No., 004-000-00345-4.

Model Number & Serial Number Location

The tub model and serial numbers are located above the pump area on the backside of the bathtub. Your installer should have a service access panel in this location. Look for a label which resembles the one on the right.

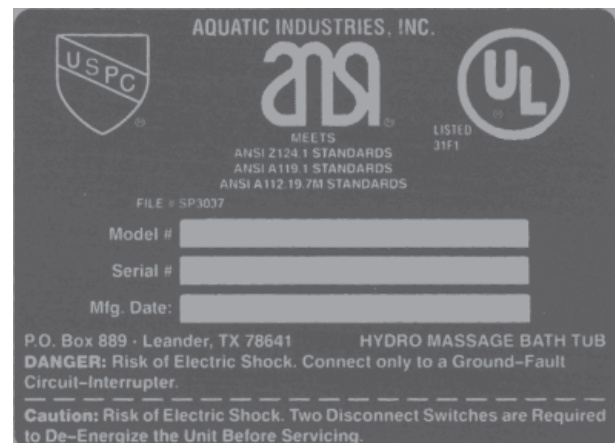

MAINTENANCE AND CARE

INITIAL CLEANING:

Before tub is used, the whirlpool system should be cleaned and disinfected. Remove all debris and clean tub before putting whirlpool into service. **DO NOT USE ABRASIVE CLEANERS ON THE ACRYLIC FINISH.** Use a non-abrasive detergent and rinse well after cleaning.

- Fill the tub with HOT water to a level 2" above the highest jet.
- Add 2 teaspoons of low-sudsing automatic dishwashing detergent and no more than 4 ounces of household bleach to the water.
- Operate whirlpool for 10 minutes. Drain. **Note:** To effectively clean both the whirlpool and air bath system, you must operate them both. (See sections entitled "Main Keypad" [Diagram 5A] and "Keypad #2" [Diagram 5C], pages 13-14).
- Refill with cold water and operate whirlpool for 5 minutes. Drain.

WHIRLPOOL SYSTEM CLEANING:

To remove accumulations of bath residue from the whirlpool system, we recommend that you purge it at least twice a month, or more depending on usage. To do this, follow this simple procedure. Fill the bath with hot water (not exceeding 140° F). Add to the hot water, 4 (6) tablespoons of low foaming detergent such as liquid Cascade or Calgonite and 24 (48) oz. of liquid household bleach, such as Clorox [use lesser amounts shown for 5-foot bathtubs, greater amounts in parentheses for larger bathtubs]. Run the bath for 5 to 10 minutes. Drain the bath completely and refill with cold water only. Run the whirlpool for 5 to 10 minutes, then drain the bath completely. Depending on the usage and/or the content of the local water supply, more frequent purging may be necessary.

NOTE: DO NOT USE OIL OR OIL BASED BATH ADDITIVES.

If you want to use any kind of bath additive, use only a small amount of low-foaming powder or crystal substance; the whirlpool action intensifies the foaming properties of soaps.

The use of certain bubble baths and bath additives may increase the level of accumulations of bath residue in the whirlpool system. If excess accumulations persist, you should discontinue use of these products.

If you have followed the monthly purging instructions and still have an excess accumulation of bath residue and desire an alternative cleaning mechanism, we recommend **SUPER SYSTEMS CLEAN PLUS** manufactured by Stearns Packaging Corporation to rectify this condition. This may be obtained by calling Aquatic Industries, Inc., at (800) 555-5324. It is recommended that you follow the instructions provided by the manufacturer with the product. Repeated use may be necessary. **SUPER SYSTEMS CLEAN PLUS** does not replace the necessity to purge your whirlpool system at least twice a month with a low foaming detergent and bleach.

SURFACE CLEANING:

Use common household, non-abrasive cleaners for most cleaning jobs. Rinse well and dry with a clean cloth. Never use abrasive cleaners. Do not allow your Lucite® acrylic surface to come into contact with products such as acetone (nail polish remover), nail polish, dry cleaning solution, lacquer thinners, gasoline, pine oil, etc. Remove dust with a soft, dry cloth. Clean grease, oil, paint, and ink stains with isopropyl (rubbing) alcohol.

JET CLEANING:

Most Millennium jets (excluding the 2 Fan Jets) are removable, and can simply be put into the dishwasher for easy cleaning. See Jet Operation Instructions for removal, pages 24-26. (Note: Use top rack of dishwasher and remove before the drying cycle starts.) The Fan Jets can be cleaned with a bottle brush and warm, soapy water.

MAINTENANCE AND CARE

SURFACE SCRATCH REMOVAL:

Minor scratches may be removed by polishing your tub with a non-abrasive car polish, followed by buffing. Deeper scratches can be removed by:

- Sanding with wet 400 grit sandpaper.
- Sanding with wet 600 grit sandpaper.
- Sanding with wet micro-grit sandpaper.
- Buff out using car polish.

REPAIR:

The installation and service of your whirlpool bath should be performed only by a qualified plumber and electrician. Remember when contacting your dealer always have your serial number, proof of purchase and model number available. This will ensure a quick response on warranty items.

The model and serial numbers are located above the pump on the backside of the whirlpool.

NOTE: ALL WARRANTY REPAIRS MUST BE AUTHORIZED BY AQUATIC BEFORE WORK IS STARTED.
FOR SERVICE, ALWAYS CONTACT YOUR DEALER.

CAUTION: Care should be taken to prevent inappropriate chemicals coming in contact with the Lucite® acrylic surface. Please read and observe all instructions and/or warnings on containers containing substances you contemplate applying to your whirlpool. Any failure to comply may void your warranty.

WATER QUALITY ISSUES:

Owners of fill and drain whirlpool bathtubs need to know basic information concerning water quality: how it affects performance and enjoyment of the operation of their tubs, and steps that can be taken by the owner to correct related problems. Important issues are the microbiological and chemical quality of the water.

MICROBIOLOGICAL QUALITY:

Microbes are present in water supplied by individual wells or water systems and even in the air around us. These microbes are usually in amounts below what is noticeable. Microbes from the water or air or from a bathers body may settle on wetted surfaces such as a whirlpool bathtub's surface or piping systems where they can grow in numbers where we can notice them. With regards to whirlpool bathtubs, brown/black fungi/mold or pigmented (colored) bacteria can be noted.

Fungi/Mold- Fungi and mold are always present. The levels are usually such that we do not notice them. When moisture and temperature are sufficient, the organisms will grow to levels that we may smell and/or see. The best example of such growth is the very common black growth on the bottom of shower curtains. The best solution to keep these surfaces free from growth is frequent cleaning.

Pigmented Bacteria- Water utilities from all over the United States have experienced calls from consumers inquiring and complaining about pinkish substance on bathroom fixtures that is very persistent, appearing in the shower, sink and along the water line of toilet bowls. With whirlpool bathtubs, the formation of this colored substance may be particularly pronounced in white tubs. The residue is less likely a problem associated with water quality than with naturally occurring airborne bacteria. The bacteria may produce a pinkish film, and sometimes a dark gray film, on surfaces that are regularly moist, including toilet bowls, shower heads, sink drains, and tiles. The problem is more common in humid areas of the country. In any particular case, the determination of the exact species of bacteria causing the problem would require lengthy and costly laboratory testing; however, most experts believe the bacteria responsible is *Serratia marcescens*. These bacteria thrive on moisture, dust and phosphates, and are widely distributed in soil, food and also in animals. The American Water Works Association suggests that short of buying pink fixtures, the best solution to keep these surfaces free from the bacterial film is continual cleaning. The AWWA recommends a chlorine containing the compound as the best cleaner and avoiding abrasives to avoid scratching fixtures, which will make them more susceptible to bacteria.

MAINTENANCE AND CARE

WATER QUALITY ISSUES:

CHEMICAL QUALITY:

The water supplied by individual wells or water systems always contains chemicals, usually in amounts below those which the consumer would notice. Examples of such chemicals, which are of potential concern for the owners of fill and drain whirlpool bathtubs, are calcium and magnesium salts, copper, iron, manganese and sulfates. When these chemicals are present in sufficient amounts, they may cause problems in whirlpool bathtubs. You should contact your water supply or treatment company and follow their suggestions for treatment.

Calcium and Magnesium Salts- Collectively, the various compounds of calcium and/or magnesium are referred to as salts. Calcium and magnesium salts are often found in ground water supplies and cause "hardness" in water. Hard and soft water are relative terms. Hard water retards the cleaning action of soaps and detergents, causing expense in the form of extra work and cleaning agents. When hard water is heated, it will deposit a hard scale. With regard to whirlpool bathtubs, high calcium and/or magnesium levels may result in the formation of white stains and scale formation on the inside of the tubs, especially noticeable with colored tubs. If this occurs, you need to contact the water supplier to determine the calcium and/or magnesium content and/or corrosion potential of the water and follow their suggestions for treatment. If you are on an individual well, you need to contact a water treatment company to test your water and suggest solutions if a problem is present.

Iron- Iron is found in many natural waters especially from wells. Iron in water can also result from the corrosion of piping in the water supply system, such as cast iron mains or galvanized steel service lines, or galvanized piping in the home water system. High iron levels may result in the formation of brown stains in the vicinity of the faucet outlets of various fixtures in the home. With whirlpool bathtubs, the staining may be particularly pronounced because the aeration action can oxidize iron to a form that settles out on the inside of the tubs, especially noticeable in white tubs. If high iron in the water is present, you can also notice rust colored deposits in your toilet tank or dishwasher. If this occurs, you need to contact the water supplier to determine the iron content and/or corrosion potential of the water and follow their suggestions for treatment. If you are on an individual well, you need to contact a water treatment company to test your water and suggest solutions if a problem is present.

Manganese- Manganese is found in many natural waters, especially from wells. High manganese levels may result in the formation of small black particles that can stain laundry, especially noticeable with whites such as sheets or towels. With whirlpool bathtubs, the formation of small black particles may be particularly pronounced because the aeration action in the tub can oxidize manganese to an insoluble form that is especially noticeable with white tubs. If high manganese in the water is present, you may also notice black stains on white laundry. If this occurs, you need to contact the water supplier to determine the manganese content of the water and follow their suggestions for treatment. If you are on an individual well, you need to contact a water treatment company to test your water and suggest solutions if a problem is present.

TREATMENT:

If you have contacted your water supplier and followed its instructions and you are still having problems, you need to increase the frequency of applications of low-foaming detergent/bleach starting from bi-monthly purging down to using it every other day as required to eliminate your particular problem.

The use of certain bath oils, bubble baths and bath additives may increase the level of accumulations of bath residue in the whirlpool system. More frequent cleaning may be necessary if these products are used in the whirlpool tub. If excess accumulations persist, you should discontinue use of these products.

If you have followed the monthly purging instructions and still have an excess accumulation of bath residue and desire an alternative cleaning mechanism, we recommend **SUPER SYSTEMS CLEAN PLUS** manufactured by Stearns Packaging Corporation to rectify this condition. This may be obtained by contacting Aquatic Industries at (800) 555-5324. It is recommended that you follow the instructions provided by the manufacturer with the product. Repeated use may be necessary. **SUPER SYSTEMS CLEAN PLUS** does not replace the necessity to purge your whirlpool system at least once a month with a low foaming detergent and bleach.

TROUBLESHOOTING GUIDE

WARNING: Always turn off power at the main electrical service panel when servicing your whirlpool.

SYMPTOMS	POSSIBLE PROBLEMS	SUGGESTED SOLUTIONS
Motor does not start	<ol style="list-style-type: none"> 1) GFCI or circuit breaker in OFF position. 2) Fuses blown or thermal overload open. 3) Locked motor shaft. 4) Motor windings burned out. 5) Defective starting switch inside single-phase motor. 6) Disconnected or defective wiring. 7) Low voltage. 	<ol style="list-style-type: none"> 1) Reset GFCI. 2) Contact your electrician. 3) Contact Aquatic Industries, Inc. 4) Contact Aquatic Industries, Inc. 5) Contact Aquatic Industries, Inc. 6) Check and reconnect if needed. 7) Contact your electrician.
Motor does not reach full speed	<ol style="list-style-type: none"> 1) Low voltage. 2) Motor windings connected for wrong voltage. 3) Wiring too small. 	<ol style="list-style-type: none"> 1) Contact your electrician. 2) Contact Aquatic Industries, Inc. 3) Contact your electrician.
Low pump pressure	<ol style="list-style-type: none"> 1) Pump running at reduced speed. 	<ol style="list-style-type: none"> 1) See above.
Motor overheats (protector trips)	<ol style="list-style-type: none"> 1) Low voltage. 2) Motor windings connected for wrong voltage. 3) Inadequate ventilation. 4) Wiring too small. 	<ol style="list-style-type: none"> 1) Contact your electrician. 2) Contact Aquatic Industries, Inc. 3) Refer to installer/dealer. 4) Contact your electrician.
Fiber Optic lighting system doesn't function	<ol style="list-style-type: none"> 1) Check fuse on Light Control Box. 	<ol style="list-style-type: none"> 1) Contact Aquatic Industries, Inc.
Pump delivers no water	<ol style="list-style-type: none"> 1) Jets are closed. 2) Leakage of air into suction system. 3) Impeller clogged. 	<ol style="list-style-type: none"> 1) Open jets. 2) Check suction screen for clogs. 3) Clean and unplug.
Low pump capacity	<ol style="list-style-type: none"> 1) Suction or discharge line partly plugged. 2) Pump running at reduced speed. 3) Impeller clogged. 	<ol style="list-style-type: none"> 1) Clean and unplug. 2) See "Motor does not reach full speed." 3) Clean and unplug.
Noisy pump and motor	<ol style="list-style-type: none"> 1) Worn motor bearings. 2) Pumps touching a stationary object. 3) Suction line partly plugged. 4) Pump not supported properly. 	<ol style="list-style-type: none"> 1) Contact Aquatic Industries, Inc. 2) Refer to installer/dealer. 3) Clean and unplug. 4) Contact Aquatic Industries, Inc. (If you have a remote pump, refer to installer/dealer.)
Leakage of water at shaft	<ol style="list-style-type: none"> 1) Shaft seal requires replacement. 	<ol style="list-style-type: none"> 1) Contact Aquatic Industries, Inc.
Leaking unions	<ol style="list-style-type: none"> 1) O-ring missing or damaged. 2) Plumbing in a bind. 3) Loose unions. 	<ol style="list-style-type: none"> 1) Contact Aquatic Industries, Inc. 2) Contact Aquatic Industries, Inc. 3) Tighten unions.
Vibration noise	<ol style="list-style-type: none"> 1) Tub or tub plumbing is touching tile/wall. 2) Pump is touching framing. 	<ol style="list-style-type: none"> 1) Refer to installer/dealer. 2) Refer to installer/dealer.
Air Bath system does not operate	<ol style="list-style-type: none"> 1) No power to air blower. 2) Blower Control Box is not plugged in. 3) Control Panel connector to controller box is disconnected. 4) Blower Motor is disconnected from control box. 	<ol style="list-style-type: none"> 1) Reset circuit breakers and GFCI if tripped. Check fuses and replace if bad. 2) Make sure plug is fully inserted into the outlet. 3) Check and reconnect if needed. 4) Plug Blower into control box.
Blower turns off by itself or before time elapses	<ol style="list-style-type: none"> 1) Blower motor overheated and thermal protection device deactivated motor (possibly low voltage). 2) GFCI tripped. 	<ol style="list-style-type: none"> 1) Check that blower has sufficient ventilation, and that the intake to the blower is not blocked, clear and allow motor to cool down. (Check service & wire size.) 2) Refer to installer/dealer.
Circuit breaker trips repeatedly	<ol style="list-style-type: none"> 1) Defective breaker. 2) Sort circuit between bath and breaker box. 3) Other items or devices are connected to the same circuit. 	<ol style="list-style-type: none"> 1) Change out breaker. 2) Refer to installer/dealer. 3) Refer to installer/dealer.
Blower does not manually shut off	<ol style="list-style-type: none"> 1) Defective control panel. 2) Defective control box. 	<ol style="list-style-type: none"> 1) Contact Aquatic Industries, Inc. 2) Contact Aquatic Industries, Inc.
Air blower does not function properly while in the pulse or wave modes	<ol style="list-style-type: none"> 1) Speed of air setting is set too low. 	<ol style="list-style-type: none"> 1) Change the air speed setting to a mid-range setting before switching to wave or pulse modes.

UNIVERSAL REMOTE SETUP CODES

BRAND NAME	TV CODE	VCR CODE	DVD CODE	CD PLAYER CODE	AMPLIFIER CODE	TUNER CODE	CASSETTE PLAYER CODE	HOME AUTOMATION CODE	MISC. AUDIO CODE	LD PLAYER CODE
ADC						0531				
ADC	0030, 0019									
Adcom						0616				
Admiral	0093, 0463	0048, 0209								
Adventura		0000								
Aiko	0092	0278								
Aiwa		0037, 0000		0157, 0124	0406	0158, 0189, 0121, 0405	0029, 0197		0010, 0159, 0404	
Akai	0030	0041				0224				
Alaron	0179									
Ambassador	0177									
America Action	0180	0278								
American High		0035								
Ampro	0751									
Anam	0180									
Asha		0240								
Audiovox	0451, 0180, 0092, 0623	0037								
Baysonic	0180									
Beaumarck		0240								
Belcor	0019									
Bell & Howell	0154, 0016	0104								
Bradford	0180									
Bockwood	0019									
Brocksonic			0209							
Broksonic	0236, 0463	0184, 0121, 0209, 0002								
Burmester				0420						
CCE		0072, 0278								
CXC	0180									
California Audio Lab				0029						
Calix		0037								
Candle	0030, 0056									
Canon		0035								
Capetronic						0531				
Carnivale	0030									
Carver	0054	0081		0157, 0179, 0437	0269	0189, 0008, 0042, 0360	0029			
Casio						0195				
Celebrity	0000									
Cineral	0451, 0092	0278								
Citizen	0060, 0030, 0056, 0039, 0092	0037, 0278								
Clarinette						0195				
Colt		0072								
Concerto	0056									
Contec	0180									
Craig	0180	0037, 0047, 0240, 0072, 0271								
Crosley	0054									
Crown	0180, 0039									
Curtis Mathes	0047, 0054, 0154, 0051, 0451, 0093, 0060, 0030, 0145, 0056, 0016, 0039, 0166, 0466, 1147, 1347	0060, 0035, 0041, 0162			0300	0080				
Cybernex		0240								
DKK				0000						
Daewoo	0451, 0019, 0039, 0092, 0623, 0624	0045, 0278								
Daytron	0019									
Denon	0145	0042		0003, 0873	0160	0004	0076			0059
Dumont	0017, 0019									
Dwin	0720, 0774									
Dynatech		0000								
Electroband	0000									

UNIVERSAL REMOTE SETUP CODES

BRAND NAME	TV CODE	VCR CODE	DVD CODE	CD PLAYER CODE	AMPLIFIER CODE	TUNER CODE	CASSETTE PLAYER CODE	HOME AUTOMATION CODE	MISC. AUDIO CODE	LD PLAYER CODE
Electrohome		0037								
Electrohome		0037								
Emerex		0032								
Emerson	0154, 0236, 0463, 0180, 0282, 0178, 0019, 0179, 0039, 0177, 0623, 0624	0037, 0184, 0000, 0121, 0043, 0209, 0002, 0278		0305		0424				
Envision		0030								
Fisher	0154	0047, 0104		0179, 0174		0042, 0219, 0360			0052	
Fuji		0035, 0033								
Fujitsu	0179									
Funai	0180, 0179, 0171	0000								
Futuretech	0180									
GE	0047, 0051, 0451, 0093, 0282, 0178, 0021, 0135, 1147, 1347	0060, 0035, 0048, 0240						0240		
Garrard		0000		0420, 0393		0463, 0424				
Genexxa				0032, 0305						
Gibraltar	0017, 0030, 0019									
Go Video		0526								
GoldStar	0030, 0178, 0019, 0056	0037, 0038								
Gradiente	0053, 0056	0000								
Grunpy	0180, 0179									
Hi-Q		0047								
Hallmark	0178									
Harley Davidson	0179	0000								
Harman / Kardon	0054	0081, 0038	0582	0157, 0173	0892	0110, 0189, 0891	0182, 0029		0477	
Harvard	0180									
Harwood		0072								
Headquarter		0046								
Hitachi	0145, 0056, 0151	0000, 0042, 0041		0032						
Hughes Net. Sys.		0042								
Infinity	0054									
Inteq	0017									
JBL	0054					0110			0477	
JCB	0000									
JVC	0053	0067, 0041	0558	0072	0331	0074	0244, 0273		0073	
Jenson		0041								
Jerrold									0459, 0520	
KEC	0180	0037, 0278								
KTV	0180, 0030, 0039									
KLH		0072								
Kenwood	0030, 0019	0067, 0041, 0038	0534	0028, 0037, 0190, 0681, 0826		0027, 0186, 0042, 0077,	0070			
Kodak		0035, 0037								
Koss						0424				
Krell				0157						
LG	0056									
LXI	0047, 0054, 0154, 0156, 0178	0037		0305		0181				
Linn				0157	0269	0189				
Lloyd's		0000				0195				
Logik	0016	0072								
Lutron								0597		

UNIVERSAL REMOTE SETUP CODES

BRAND NAME	TV CODE	VCR CODE	DVD CODE	CD PLAYER CODE	AMPLIFIER CODE	TUNER CODE	CASSETTE PLAYER CODE	HOME AUTOMATION CODE	MISC. AUDIO CODE	LD PLAYER CODE
Luxman	0056									
MCS				0029		0039, 0346				
MEI		0035								
MGA	0150, 0030, 0178, 0019	0240, 0043								
MGN Technology		0240								
MTC	0060, 0030, 0019, 0056	0240, 0000		0420						
Magnasonic		0278								
Magnavox	0054, 0030, 0179	0035, 0039, 0081, 0000, 0149	0503	0157, 0305	0269	0531, 0189, 0195, 0391	0029			
Magnin		0240								
Majestic	0016									
Marantz	0054, 0030	0035, 0081		0029, 0157, 0180	0269	0039, 0189	0029			
Martz		0037								
Matsushita	0250	0035, 0162, 0454								
Megatron	0178, 0145									
Memorex	0154, 0250, 0463, 0150, 0178, 0056, 0016	0035, 0037, 0048, 0039, 0047, 0240, 0000, 0104, 0209, 0046, 1162, 1262								
Midland	0047, 0017, 0051, 0039, 0135									
Minolta		0042								
Minutz	0021									
Mission				0157						
Mitsubishi	0093, 0150, 0178, 0019	0048, 0067, 0043	0521							0059
Modulaire						0195				
Motorola	0093	0035, 0048								
Multitech	0180	0000, 0072								
NAD	0156, 0178, 0166					0320				0059
NEC	0030, 0019, 0056	0104, 0067, 0041, 0038								
NSM				0157						
NTC	0092									
Nakamichi						0097, 0347				
Nikko	0030, 0178, 0092	0037		0174						
Noblex		0240								
Onwa	0180									
Olympus		0035								
One For All								0167		
Onkyo			0503	0101, 0868		0135	0135, 0282			
Optimus	0154, 0250, 0166	0037, 0048, 0104, 0162, 0454, 1062, 1162, 1262		0000, 0032, 0179, 0305, 0037, 0420, 0145, 0468, 0437		0531, 0670, 0186, 0042, 0177, 0181, 0219, 0738, 0801, 1023	0027, 0220			
Optonica	0093, 0165									
Orion	0236, 0463, 0179	0184, 0209, 0002								
Panasonic	0051, 0250	0035, 0162, 0225, 0454, 1162	0490	0029, 0303	0308	0039, 0309	0229			
Parasound				0420						
Penney	0047, 0156, 0051, 0060, 0030, 0178, 0021, 0019, 0056, 0039, 0135, 1347	0035, 0037, 0240, 0042, 0038				0195				

UNIVERSAL REMOTE SETUP CODES

BRAND NAME	TV CODE	VCR CODE	DVD CODE	CD PLAYER CODE	AMPLIFIER CODE	TUNER CODE	CASSETTE PLAYER CODE	HOME AUTOMATION CODE	MISC. AUDIO CODE	LD PLAYER CODE
Pentax		0042								
Philco	0054, 0463, 0030, 0145, 0019	0035, 0209								
Philips	0054	0035, 0081	0503, 0539	0157, 0626	0269, 0892	0189, 0391	0029			
Pilot	0030, 0019, 0039	0037								
Pioneer	0166	0067	0525, 0571	0032, 0305, 0468, 0244	0013, 0300	0531, 0014, 0150, 0630, 0080, 1023	0027, 0220, 0099			0059
Portland	0019, 0039, 0092									
Prism	0051									
Profitronic		0240								
Proscan	0047	0060	0522							
Protec		0072								
Proton	0178, 0466			0157						
Pulsar	0017, 0019	0039								
QED				0157						
Quarter		0046								
Quartz		0046								
Quasar	0051, 0250, 0165	0035, 0162, 0454, 1162		0029		0039				
RCA	0047, 0051, 0093, 0019, 0090, 0135, 1047, 1147, 1247, 1347	0060, 0035, 0048, 0240, 0042, 0149	0522	0179, 0305, 0053, 0764,		0531, 0054, 0346, 0360, 0530			0056	
Radio Shack	0047, 0154, 0165, 0180, 0030, 0178, 0019, 0056	0000						0240		
Radix		0037								
Randex		0037								
Realistic	0154, 0165, 0180, 0030, 0178, 0019, 0056, 0039	0035, 0037, 0048, 0047, 0000, 0104, 0046		0179, 0420, 0180		0195, 0163, 0181				
Rotel				0157, 0420						
Runco	0017, 0030, 0603	0039								
SAE				0157						
SSS	0180, 0019									
STS		0042								
Sampo	0030, 0039									
Samsung	0060, 0030, 0178, 0019, 0056	0240, 0045	0573							
Samsux	0039									
Sanky		0048, 0039								
Sansei	0451									
Sansui	0463	0000, 0067, 0209, 0041, 0271		0157, 0305		0189, 0346	0029			
Sanyo	0154	0047, 0240, 0104, 0046		0179		0219, 0801				
Scientific Atlanta									0460	
Scimitsu	0019									
Scotch	0178									
Scott	0236, 0180, 0178, 0019, 0179	0184, 0045, 0121, 0043		0305		0163, 0322				
Sears	0047, 0054, 0154, 0156, 0178, 0179, 0056, 0171	0035, 0037, 0047, 0000, 0042, 0104, 0046		0305						
Security System								0167		
Semivox	0180									

UNIVERSAL REMOTE SETUP CODES

BRAND NAME	TV CODE	VCR CODE	DVD CODE	CD PLAYER CODE	AMPLIFIER CODE	TUNER CODE	CASSETTE PLAYER CODE	HOME AUTOMATION CODE	MISC. AUDIO CODE	LD PLAYER CODE
Semp	0156	0045								
Sharp	0093, 0165, 0039	0048		0037, 0180, 0861		0186				
Singer		0072								
Sony	0000	0035, 0032, 0000, 0033	0533	0000, 0185, 0490	0220, 0689	0158, 0168, 0474	0243, 0170, 0291		0010, 0159	0193, 0201
Soundesign	0180, 0178, 0179			0145		0670				
Squareview	0171									
Starcom									0459	
Starlite	0180									
Supreme	0000									
Sylvania	0054, 0030	0035, 0081, 0000, 0043								
Symphonic	0171	0000								
TMK	0178, 0056, 0177	0240								
Tandy	0093									
Tascam				0420						
Tatung		0041								
Teac		0000, 0041		0420, 0393, 0174, 0180		0463, 0163				
Technics	0051, 0250	0035, 0162	0490	0029, 0303	0308	0039, 0309, 0208	0229			
Technol Ace	0179									
Techwood	0051, 0056									
Teknika	0054, 0180, 0150, 0060, 0019, 0179, 0056, 0016, 0039, 0092	0035, 0037, 0000								
Telefunken	0056									
Theta Digital			0571							
Thomas		0000								
Toshiba	0154, 0156, 0060	0045, 0043	0503							
Totevision	0039	0037, 0240								
Unitech			0240							
Universal X10								0167		
Vector		0045								
Vector Research	0030	0038								
Victor	0053			0072	0331	0074	0273			
Video Concepts		0045								
Videosonic		0240								
Vidikron	0054									
Vidtech	0178, 0019									
Wards	0054, 0165, 0030, 0178, 0021, 0019, 0179, 0056, 0016	0060, 0035, 0048, 0047, 0081, 0240, 0000, 0042, 0072, 0149		0157, 0053	0013	0158, 0014, 0189, 0080, 0054	0027			
White Westinghouse	0463, 0623, 0624	0209, 0278								
X10								0167		
XR-1000		0035, 0000, 0072								
Yamaha	0030, 0019	0038	0490, 0545	0036, 0187	0354	0176, 0186	0097, 0094			
Yorx				0461		0195				
Zenith	0017, 0463, 0016, 0092	0039, 0000, 0209, 0033	0503, 0591			0857				



REPLACEMENT PARTS ORDER FORM

FOR MILLENNIUM SERIES

How To Use:

1. Find your part on the map and make note of its number & letter.
2. Using map number and letter, choose part number and select color (or finish) on parts list provided on pages 41-42.
3. Fill out the form below with the selected information. Fax or send to Aquatic.
4. Call AQUATIC for parts pricing and shipping charges.

IMPORTANT!

The following information **MUST** accompany your order:

Serial Number, Model Number/Name, Purchase Date and Color

PLEASE FILL OUT COMPLETELY:

SHIP TO:

Name _____

Company _____

Address _____

City _____ State _____ Zip _____

Phone _____ Fax _____

BILL TO:

Name _____

Company _____

Address _____

City _____ State _____ Zip _____

Phone _____ Fax _____

Serial # (Invoice #) _____ Model Name _____

Model # _____ Color _____ Purchase Date _____

Quantity	Part No.	Description	Color/Finish	Price
_____	_____	_____	_____	_____
_____	_____	_____	_____	_____
_____	_____	_____	_____	_____
_____	_____	_____	_____	_____
_____	_____	_____	_____	_____
_____	_____	_____	_____	_____

Mail orders to:

AQUATIC INDUSTRIES, INC.
P.O. Box 889 • Leander, TX 78646-0889
Phone (800) 928-3707 • Fax (888) 296-7450

MILLENNIUM SERIES

REPLACEMENT PARTS ORDER MAP

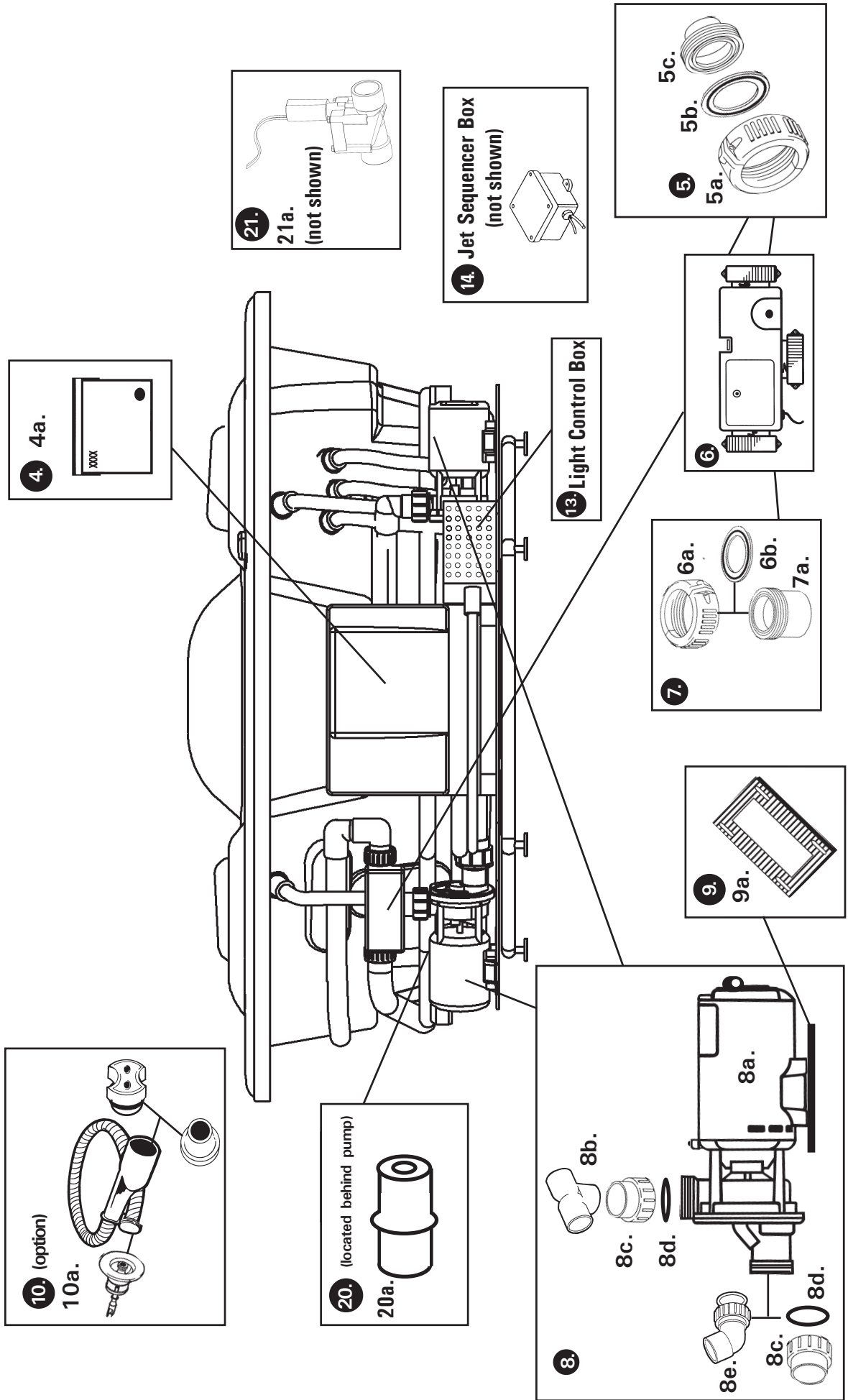



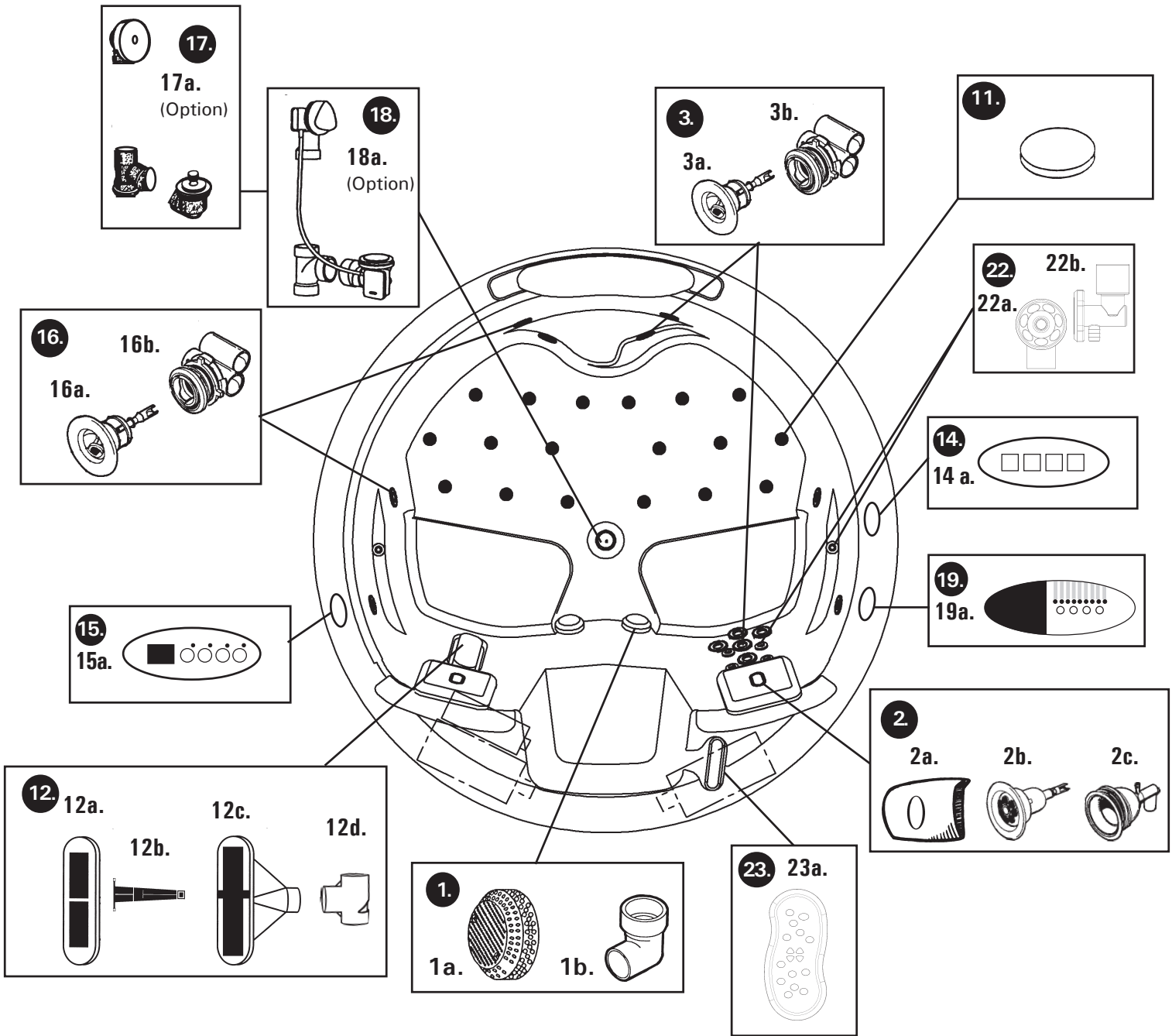

MILLENNIUM SERIES

REPLACEMENT PARTS ORDER MAP/OVERVIEW

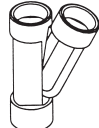

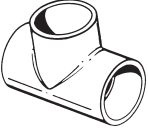
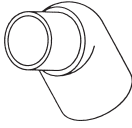
Assorted Fittings

FX101  Coupler	FX102  Y Fitting	FX103  Street 90°	FX104  90° fitting	FX105  T fitting	FX106  Street 45°	FX107  45° fitting
1" or 1 1/2"	1" only	1" or 1 1/2"	1" or 1 1/2"	1" or 1 1/2"	1" or 1 1/2"	1" or 1 1/2"

MILLENNIUM SERIES

REPLACEMENT PARTS ORDER MAP/OVERVIEW

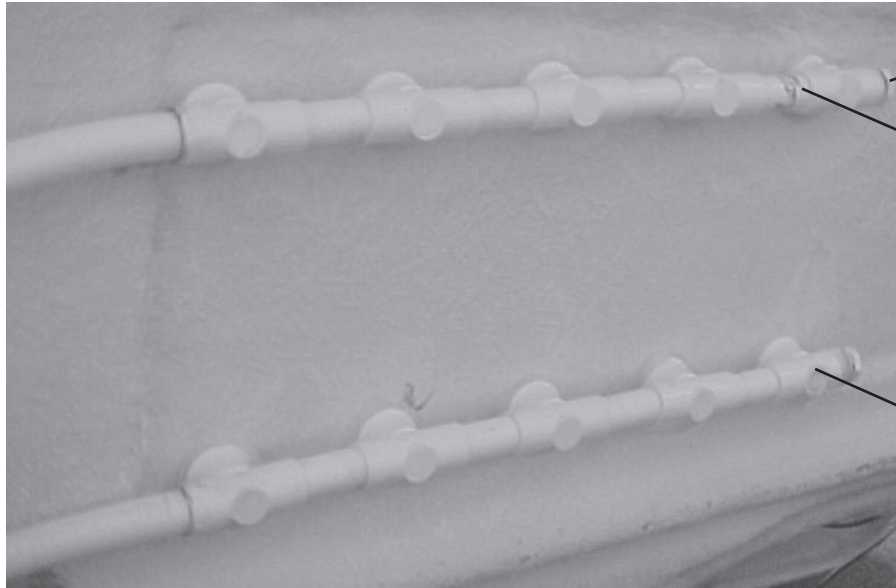

24a.

24b.

12.

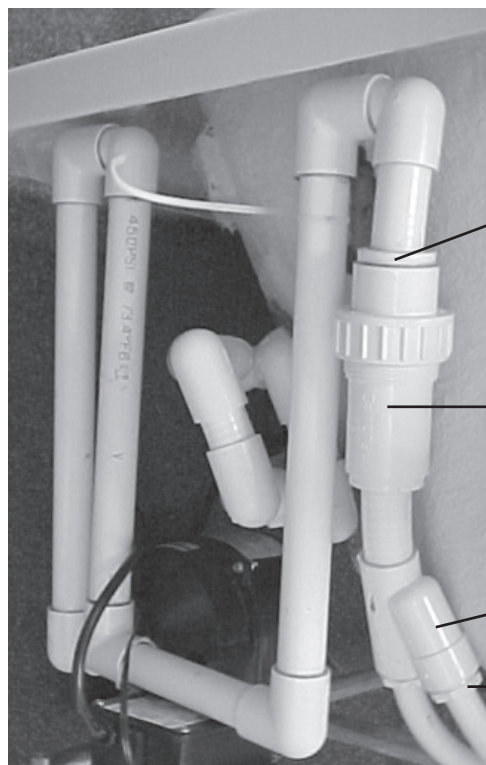

25a.

25b.

25c.

25d.

Millennium Series Parts List

<u>ILLUSTRATION NO.</u>	<u>DESCRIPTION</u>	<u>PART #</u>	<u>SPECIFY COLOR/FINISH/MODEL#</u>
1a.	Suction Cover	8152HVSUCVRRXX	Specify Color/Finish
1b.	90 deg. (close fit)	8412FTG	---
2a.	Neck Jet Pillow	9403PILL*	Specify Color
2b.	Neck Jet	88BARREL	---
2c.	Neck Jet Fitting	88ASSYWH	---
3a.	Rotary Massage Elite Jet	86SWIRLXX*	Specify Color
3b.	Rotary Massage Elite Jet Fitting	86ASSYXX*	Specify Color (white or clear)
4a.	Electronic Box (complete)	1000	---
5a.	2 pc. Heater Split Nut	84005491FTG	---
5b.	Gasket / O-Ring	8722GASKET	---
5c.	1.5 in. x 1 in. Tailpiece	8417SOCKET	---
6.	4 KW Heater (stainless heat tube)	8097HEAT	---
6a.	2 pc. Heater Split Nut	84005491FTG	---
6b.	Gasket / O-Ring	8722GASKET	---
7a.	1.5 in. Tailpiece	8417SPIGOT	---
8a.	2 HP, 110V, 3-Speed Pump	8150MOTOR	---
8b.	Sweep "T"	8407FTG	---
8c.	1.5 in. Pump Union w/ O-Ring	8150UNION	---
8d.	O-Ring	---	---
8e.	65° Pump Union (incl. O-Ring)	8408FTG	---
9a.	Pump - "Quiet Pad"	4620PAD	---
10a.	Hand Held Jet	8AII5HHJET	Specify Color
11a.	8-Hole Snap Cap	8027INJJETWH	White
11a.	8-Hole Snap Cap	8027INJJETBO	Bone
11a.	8-Hole Snap Cap	8027INJJETBI	Biscuit
11a.	8-Hole Snap Cap	8027INJJETST	Sterling Silver
11a.	8-Hole Snap Cap	8027INJJETBK	Black
11a.	8-Hole Snap Cap	8027INJJETFA	Fawn Biege
11a.	8-Hole Snap Cap	8027INJJETGI	Ice Grey
11a.	8-Hole Snap Cap	8027INJJETIB	Innocent Blush
11a.	8-Hole Snap Cap	8027INJJETME	Mexican Sand
11a.	8-Hole Snap Cap	8027INJJETNV	Navy
11a.	8-Hole Snap Cap	8027INJJETSH	Shell
11a.	8-Hole Snap Cap	8027INJJETWR	Wild Rose
11a.	8-Hole Snap Cap	8027INJJETDB	Desert Bloom
11a.	8-Hole Snap Cap	8027INJJET10	Chrome
11a.	8-Hole Snap Cap	8027INJJET20	Polished Brass
11a.	8-Hole Snap Cap	8027INJJET30	Satin Nickel
11a.	8-Hole Snap Cap	8027INJJETPN	Polished Nickel
12.	Air Jet Housing	8027INJBDY	---
12a.	Fan Jet Cover	8460300BI	Biscuit
12a.	Fan Jet Cover	8460300BK	Black
12a.	Fan Jet Cover	8460300BO	Bone
12a.	Fan Jet Cover	8460300IB	Innocent Blush
12a.	Fan Jet Cover	8460300ST	Sterling Silver
12a.	Fan Jet Cover	8460300WH	White
12a.	Fan Jet Cover	8102ESCBR	Brass
12a.	Fan Jet Cover	8102ESCSN	Satin Nickel
12a.	Fan Jet Cover	8102ESCCR	Chrome
12a.	Fan Jet Cover	8102ESCGD	Gold
12a.	Fan Jet Cover	8102ESCPN	Polished Nickel
12b.	Fan Jet Flapper	2D460310	---
12c.	Fan Jet Body	4896383	---
12d.	Fan Jet Tee Fitting	46033900	---
13.	Fiber Optic Lighting System	1006	---
14.	Jet Sequencer Box	1001	---
14a.	Blower Keypad	1004WH	White
14a.	Blower Keypad	1004BI	Biscuit
14a.	Blower Keypad	100410	Chrome
14a.	Blower Keypad	100420	Polished Brass
14a.	Blower Keypad	100430	Satin Nickel
14a.	Blower Keypad	1004CL	Clear
14a.	Blower Keypad	1004ORB	Oil Rubbed Bronze

*To indicate color, replace "XX" with "WH" for White, "BO" for Bone, "BK" for Black, "ST" for Sterling Silver, "BI" for Biscuit, "IB" for Innocent Blush, "CR" for Chrome, "BR" for Brass, "PN" for Polished Nickel, "BN" for Satin Nickel, "GD" for Gold and "CL" for Clear.

Millennium Series Parts List

<u>ILLUSTRATION NO.</u>	<u>DESCRIPTION</u>	<u>PART #</u>	<u>SPECIFY COLOR/FINISH/MODEL#</u>
15a.	Main Keypad	1003WH	White
15a.	Main Keypad	1003BI	Biscuit
15a.	Main Keypad	100310	Chrome
15a.	Main Keypad	100320	Polished Brass
15a.	Main Keypad	100330	Satin Nickel
15a.	Main Keypad	1003CL	Clear
15a.	Main Keypad	1003ORB	Oil Rubbed Bronze
16a.	Rotary Massage Jet	87SWIRLXX*	Specify Color
16b.	Rotary Massage Jet Fitting	87ASSY	White
16b.	Rotary Massage Jet Fitting	87ASSYCL	Clear
17a.	Lift & Turn Waste and Overflow	93CPDWO	Chrome
17a.	Lift & Turn Waste and Overflow	93PBDWO	Polished Brass
17a.	Lift & Turn Waste and Overflow	93SNDWO	Satin Nickel
17a.	Lift & Turn Waste and Overflow	93PNDWO	Polished Nickel
17a.	Lift & Turn Waste and Overflow	93PGDWO	Gold
18a.	Cable Drive Waste and Overflow	---	Specify Color/Model #
19a.	Sequencer Keypad	1005WH	White
19a.	Sequencer Keypad	1005BI	Biscuit
19a.	Sequencer Keypad	100510	Chrome
19a.	Sequencer Keypad	100520	Polished Brass
19a.	Sequencer Keypad	100530	Satin Nickel
19a.	Sequencer Keypad	1005CL	Clear
19a.	Sequencer Keypad	1005ORB	Oil Rubbed Bronze
20a.	1 HP Air Blower	8000BLW	---
21a.	Sequencer Valve	8500VLV	---
22a.	Pressure Plus Jet	1023XX*	Specify Color
22b.	Pressure Plus Jet Body	1007	---
23a.	Universal Remote Control	1002	---
not shown	Venturi Check Valve	8441FTG	---
not shown	1" St. 45° Union	8411202FTG	---
not shown	Air Manifold, 8-port	8500FTG	---
not shown	Constant Tension Clamp	8000CLAMP	---
not shown	3/4" wye 22.5	8503FTG	---
24a.	1/2" Plug	8449D05FTG	---
24b.	Micro Inj. Jet Body 1/2"	8027INJBDY	---
25a.	1 1/2" x 1" Reducer	8437211FTG	---
25b.	1 1/2" Check Valve	8427FTG	---
25c.	3/4" WYE	8504FTG	---
25d.	1" x 3/4" Reducer	8506FTG	---
ASSORTED FITTINGS:			
	1" Coupler	8429010FTG	---
	1 1/2" Coupler	8429015FTG	---
	2" Coupler	8429020FTG	---
	3/4" Y-Fitting	8504FTG	---
	1" Y-Fitting	8415FTG	---
	3/4" Street 90°	8514FTG	---
	1" Street 90°	8409010FTG	---
	1 1/2" Street 90°	9409015FTG	---
	2" Street 90°	8409020FTG	---
	1/2" 90°	8406005FTG	---
	3/4" 90°	8512FTG	---
	1" 90°	8406010FTG	---
	1 1/2" 90°	8406015FTG	---
	2" 90°	8406020FTG	---
	3/4" T-Fitting	8511FTG	---
	1" T-Fitting	8401010FTG	---
	1 1/2" T-Fitting	8401015FTG	---
	2" T-Fitting	8510FTG	---
	1" Street 45°	8411202FTG	---
	1/2" Street 45°	8411404FTG	---
	3/4" 45°	8513FTG	---
	1" 45°	8417010FTG	---
	1 1/2" 45°	8417015FTG	---
	2" 45°	8509FTG	---

* To indicate color, replace "XX" with "WH" for White, "BO" for Bone, "BK" for Black, "ST" for Sterling Silver, "BI" for Biscuit, "IB" for Innocent Blush, "CR" for Chrome, "BR" for Brass, "PN" for Polished Nickel, "BN" for Satin Nickel, "GD" for Gold and "CL" for Clear.

Aquatic Industries, Inc. Limited Lifetime Warranty

For Millennium, Infinity, Century, LuxeAir, Luxury, and Gallery Series Whirlpools, Serenity Air Baths, Serenity Studio, HotSoak Series Baths and Restoration Series

Limited Warranty For Original Consumer For Household Usage

WHAT PRODUCTS ARE COVERED

Structures and surface finishes, pumps and blowers on the Millennium, Infinity, Century, LuxeAir, Luxury, Gallery, Serenity Air Baths, Serenity Studio, HotSoak, and Restoration Series.

Warranty Periods for Specific Components

LIFETIME WARRANTY FOR WHIRLPOOL/AIR BATH/TUB SHELL, PUMP AND BLOWER

Aquatic Industries, Inc. extends to the original consumer purchaser of the acrylic, fiberglass reinforced shell, a non-transferable lifetime warranty that the shell will retain its structural integrity and configuration and be free of water loss due to a defect in the tub shell. The warranty covers the tub shell and the factory installed pump and blower against defects in material or workmanship. This warranty does not apply to all other components (attachments to the acrylic, fiberglass reinforced shell, such as plumbing, fittings and other apparatus) because these pieces are covered below under a 2 Year Warranty.

LIFETIME SURFACE WARRANTY FOR FACE OF WHIRLPOOL/AIR BATH/TUB

The interior surface is warranted against fading, blistering, cracking and delamination due to defects in the surface materials for life. This surface warranty extends to defects due to surface material mixing or molding. This surface warranty does not apply to fading, cracking, delamination or blistering due to *excessive wear, sun fading or scouring due to cleaning.*

2 YEAR EQUIPMENT WARRANTY FOR SUPPORT EQUIPMENT, COMPONENTS, CONTROLS & PLUMBING EQUIPMENT

All support equipment; components, controls and plumbing equipment are warranted for 2 years from date of purchase, but not more than 3 years from date of manufacture, against defects in workmanship and materials. Light bulbs, fuses and pillows are not included in this two-year period. However, these accessories are warranted to be free from defects in materials and workmanship at the time of delivery to the original purchaser. Limited labor is covered for 2 years from purchase, but never more than 3 years from date of manufacture, for limited labor on the support equipment, controls, and plumbing.

EXCLUSIVE REMEDY

Aquatic Industries, Inc. will, **at its option**, repair or replace (without removal or installation) the affected components of any defective Unit or System; repair or replace (without removal or installation) the entire defective Unit or System; or refund the then-current list price of the Whirlpool, Air Bath, or Tub. In all cases, a reasonable time period must be allowed for warranty repairs to be completed.

WHAT YOU MUST DO

In order to make a claim under these warranties:

1. You must be the original consumer purchaser of the Whirlpool, Air Bath, or Tub.
2. You must promptly notify us within the warranty period of any defect and provide us with any substantiation that we may reasonably request.
Write to: **Aquatic Industries, Inc. P.O. Box 889 Leander, TX 78646.**
3. The Whirlpools, Air Baths, and Tubs must have been installed and maintained in accordance with good industry practice and the specific Aquatic Industries, Inc. directions contained in the Owner's Manual and Installation Guide.

EXCLUSIONS

These warranties do **not** extend to or do **not** cover defects caused by:

1. Shipping damage by carriers or installation errors.
2. Accident, acts of God, abuse or misuse.
3. Unreasonable use (including any use for non-bathing purposes or failure to provide reasonable and necessary maintenance as specified in Aquatic Industries, Inc. Owner's Manual and Installation Guide supplied with the Whirlpool, Air Bath or Tub).
4. Any alteration, customization, or modification of the Whirlpool/Air Bath/Tub or its components.

LIMITATIONS

1. **AQUATIC INDUSTRIES, INC. whirlpools and tubs sold for industrial, commercial and hotel use** are warranted for two years, but not more than 3 years from date of manufacture, with a 2 year limited warranty that the shell will retain its structural integrity and configuration and be free of water loss due to a defect in the tub. The interior surface/face of the whirlpool/air bath/tub is warranted against fading, blistering, cracking and delamination due to defects in the surface materials for 2 years as well. All support equipment, components, controls and plumbing equipment and limited labor on the support equipment, controls, or plumbing are warranted for 1 year from date of purchase, but not more than 2 years from date of manufacture. Pump seals, "O" rings, light bulbs, fuses and pillows are not included in this two-year period. However, these accessories are warranted to be free from defects in materials and workmanship at the time of delivery to the original purchaser.
2. **In all cases, AQUATIC INDUSTRIES, INC. reserves the right to fully satisfy its obligations under the Limited Warranties by refunding the then-current list price of the defective Whirlpool, Air Bath, or Tub (or, if the Whirlpool, Air Bath, or Tub has been discontinued, of the most nearly comparable current product).**
3. **THESE WARRANTIES ARE NON-TRANSFERABLE TO ANY OTHER PURCHASER OR PARTY OTHER THAN THE ORIGINAL CONSUMER. NO OTHER AGENT OR PARTY CAN GIVE ANY OTHER WARRANTY OR PROMISE. THIS IS THE SOLE WARRANTY FOR YOUR AQUATIC INDUSTRIES, INC. PRODUCT.**
4. **AQUATIC INDUSTRIES, INC. will not cover any installation or reinstallation costs related to this warranty, except under the limited labor allowance under the 2 Year Equipment Warranty above.**

GENERAL

This warranty gives you specific legal rights; you may also have other rights, which vary from state to state. THE DURATION OF ANY IMPLIED WARRANTIES, INCLUDING THE IMPLIED WARRANTIES OF MERCHANTABILITY AND FITNESS FOR A PARTICULAR PURPOSE, ARE LIMITED TO THE DURATION OF THE EXPRESS WARRANTIES HEREIN. AQUATIC INDUSTRIES, INC. EXPRESSLY EXCLUDES INCIDENTAL AND CONSEQUENTIAL DAMAGES, TO INCLUDE LOSS OF TIME, INCONVENIENCE, OR LOSS OF USE OF RESIDENCE, FOR ANY BREACH OF THE EXPRESS OR IMPLIED WARRANTY, INCLUDING THE IMPLIED WARRANTIES OF MERCHANTABILITY OR FITNESS FOR A PARTICULAR PURPOSE.

SOME STATES DO NOT ALLOW ANY LIMITATION ON HOW LONG AN IMPLIED WARRANTY LASTS, OR THE EXCLUSION OR LIMITATION OF INCIDENTAL OR CONSEQUENTIAL DAMAGES; SO THE ABOVE EXCLUSION MAY NOT APPLY TO YOU.

AQUATIC

AQUATIC INDUSTRIES, INC.

Fax-On-Demand System: Toll Free (877) 618-7024

11880 RR 2243 W Leander, Texas 78641

(800) 928-3707 Fax: (888) 296-7450

www.aquaticwhirlpools.com